

Micro Motion[®] ELITE[®] Coriolis Flow and Density Meters



Ultimate real world performance

- Unchallengeable ELITE performance on liquid mass flow, volume flow, and density measurements
- Best-in-class gas mass flow measurement
- Reliable two-phase flow measurement for the most challenging applications
- Designed to minimize process, mounting, and environmental effects

Best fit-for-application

- Scalable platform for the widest range of line size and application coverage including hygienic, cryogenic, high pressure, and high temperature
- Available with the broadest range of I/O offerings highlighted by expansive digital protocol support

Superior measurement confidence

- Smart Meter Verification delivers complete, traceable calibration verification, continuously or on-demand at the press of a button
- Globally leading ISO/IEC 17025 calibration facilities offers best in class uncertainty of $\pm 0.014\%$
- Intelligent sensor design mitigates the need for zero calibration in the field

Micro Motion® ELITE® Coriolis flow and density meters

Micro Motion ELITE meters provide unmatched flow and density measurement performance to deliver the ultimate control and confidence in your most complex and challenging liquid, gas, and slurry applications.

Tip

If you need help determining which Micro Motion products are right for your application, check out the [Micro Motion® Technical Overview and Specification Summary](#) and other resources available at www.emerson.com/flowmeasurement.

Achieving the ultimate flow fit for your application

- Able to achieve the best fit for your flow measurement with a wide range of tube designs and flow rate coverage to best serve your application
- Peak performance in a drainable design with a variety of industry approvals for use in strictly governed sanitary applications
- Scalable platform for a broad array of application coverage including hygienic, cryogenic, high temperature, and high pressure

Smart Meter Verification: advanced diagnostics for your entire system

- Included as standard, with the option to license coating detection and other advanced meter health diagnostics
- A comprehensive test that can be run locally or from the control room to provide confidence in your meter functionality and performance
- Verifies that your meter performs as well as the day it was installed, giving you assurance in less than 90 seconds
- Saves significant expenditure by reducing labor and outsourced calibration service costs while eliminating process interruption

Industry-leading capabilities that unleash your process potential

- Available with the most extensive offering of transmitter and mounting options for maximum compatibility with your system
- State of the art, ISO-IEC 17025 compliant calibration stands achieving $\pm 0.014\%$ uncertainty drive best in class measurement accuracy
- The most robust communication protocol offering in the industry including Smart Wireless
- True multi-variable technology measures necessary flow and density process variables simultaneously
- Widest selection of safety, country, and custody transfer approvals

Unparalleled performance in two-phase flow conditions

- Featuring the lowest frequency Coriolis sensors that ensure the two-phase mixture vibrates with the tube to drastically reduce uncertainty contributions from both the presence of liquid in a gas flow measurement, and entrained gas or aeration in liquid flow
- Unmatched MVD transmitter technology with digital signal processing (DSP) delivers the fastest response and refresh rates enabling accurate batch and other two-phase flow measurement
- Measure fluids with any Gas Void Fraction (GVF). The relationship to mass flow accuracy varies with application

Measurement principles

As a practical application of the Coriolis effect, the Coriolis mass flow meter operating principle involves inducing a vibration of the flow tube through which the fluid passes. The vibration, though it is not completely circular, provides the rotating reference frame which gives rise to the Coriolis effect. While specific methods vary according to the design of the flow meter, sensors monitor and analyze changes in frequency, phase shift, and amplitude of the vibrating flow tubes. The changes observed represent the mass flow rate and density of the fluid.

Mass flow measurement

The measuring tubes are forced to oscillate producing a sine wave. At zero flow, the two tubes vibrate in phase with each other. When flow is introduced, the Coriolis forces cause the tubes to twist resulting in a phase shift. The time difference between the waves is measured and is directly proportional to the mass flow rate.

Watch this video to learn more about how a Coriolis flow meter measures mass flow and density (click the link and select **View Videos**): <https://www.emerson.com/en-us/automation/measurement-instrumentation/flow-measurement/coriolis-flow-meters>.

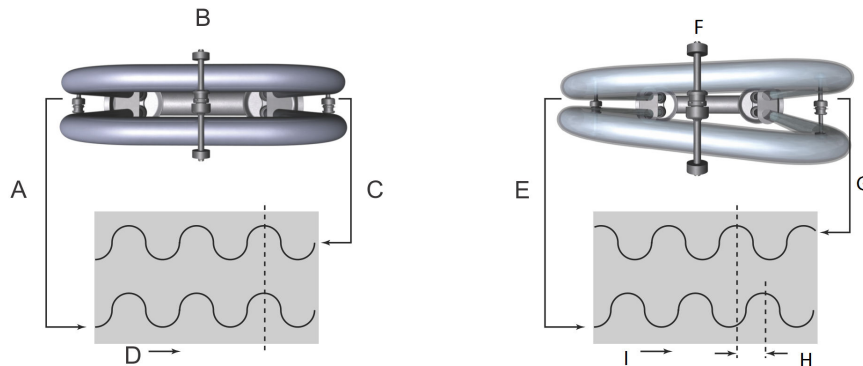

- A. Inlet pickoff displacement
- B. No flow
- C. Outlet pickoff displacement
- D. Time
- E. Inlet pickoff displacement
- F. With flow
- G. Outlet pickoff displacement
- H. Time difference
- I. Time

Density measurement

The measuring tubes are vibrated at their natural frequency. A change in the mass of the fluid contained inside the tubes causes a corresponding change to the tube natural frequency. The frequency change of the tube is used to calculate density.

Temperature measurement

Temperature is a measured variable that is available as an output. The temperature is also used internal to the sensor to compensate for temperature influences on Young's Modulus of Elasticity.

Meter characteristics

- Measurement accuracy is a function of fluid mass flow rate independent of operating temperature, pressure, or composition. However, pressure drop through the sensor is dependent upon operating temperature, pressure, and fluid composition.
- Specifications and capabilities vary by model and certain models may have fewer available options. For detailed information regarding performance and capabilities, either contact customer service or refer to www.emerson.com/flowmeasurement.
- All meters with the CMF designation (CMF, CMFHC, CMFS) are members of the ELITE meter family and should be considered to possess the same qualities and specifications as other ELITE family meters unless specifically noted.
- The letter at the end of the base model code (for example, CMF100M) represents wetted part material and/or application designation: M = 316L stainless steel, L = 304L stainless steel, H = nickel alloy C22, P = high pressure, A = high temperature 316L stainless steel, B = high temperature nickel alloy C22, Y = Super Duplex (UNS S32750). Detailed information about the complete product model codes are described later in this document.

Performance specifications

Reference operating conditions

For determining the performance capabilities of our meters, the following conditions were observed/utilized:

- Water at 68 °F (20.0 °C) to 77 °F (25.0 °C) and 14.5 psig (1.000 barg) to 29 psig (2.00 barg)
- Air and Natural Gas at 68 °F (20.0 °C) to 77 °F (25.0 °C) and 500 psig (34.47 barg) - 1,450 psig (99.97 barg)
- Accuracy based on industry leading accredited calibration stands according to ISO 17025/IEC 17025
- All models have a density range up to 5 g/cm³ (5000 kg/m³)

Accuracy and repeatability

Accuracy and repeatability on liquids and slurries

Performance Specification	Standard	Optional ⁽¹⁾
Mass/volume flow accuracy ⁽²⁾⁽³⁾	±0.10% of rate	±0.05% of rate
Mass/volume flow repeatability	0.05% of rate	0.025% of rate
Density accuracy ^{(3) (4)}	±0.0005 g/cm ³ (±0.5 kg/m ³)	±0.0002 g/cm ³ (±0.2 kg/m ³)
Density repeatability	0.0002 g/cm ³ (0.2 kg/m ³)	0.0001 g/cm ³ (0.1 kg/m ³)
Temperature accuracy	±1 °C ±0.5% of reading; BS1904 Class, DIN43760 Class A (±0.15 +0.002 x T °C)	
Temperature repeatability	0.2 °C	
Environmental temperature compensation	BS1904 Class, DIN 43760 Class B (±0.30 +0.005 x T °C) - Qty 3 case sensors ⁽¹⁾	

(1) Not available on all models.

(2) Stated flow accuracy includes the combined effects of repeatability, linearity, hysteresis, orientation and other non-linearities.

(3) For cryogenic applications with process temperatures below -100 °C, the liquid mass flow accuracy is ±0.35% of rate and density accuracy specification does not apply.

(4) The standard density accuracy option for the sensor models CMFS007, CMFS010, and CMFS015 is ±0.002 g/cm³ (±2 kg/m³), for models CMFS010 and CMFS015 optional accuracy is ±0.0005 g/cm³ (±0.5 kg/m³).

Accuracy and repeatability on gases

Performance specification	Standard models
Mass flow accuracy ⁽¹⁾	±0.25% of rate
Mass flow repeatability	0.20% of rate
Temperature accuracy	±1 °C ±0.5% of reading; BS1904 Class, DIN43760 Class A (±0.15 +0.002 x T °C)
Temperature repeatability	0.2 °C



(1) Stated flow accuracy includes the combined effects of repeatability, linearity, hysteresis, orientation and other non-linearities.

Liquid flow rates



Nominal flow rate

Micro Motion has adopted the term nominal flow rate, which is the flow rate at which water at reference conditions causes approximately 14.5 psig (1 barg) of pressure drop across the meter.

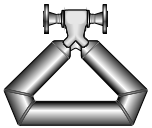
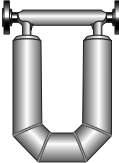

Mass flow rates for stainless steel models: 304L (L), 316L (M/A), and Super Duplex (Y)

Style	Model	Nominal line size		Nominal flow rate		Maximum flow rate	
		inch	mm	lb/min	kg/h	lb/min	kg/h
	CMFS007M	1/12"	DN1	1.28	35.0	1.50	40.9
	CMFS010M	1/10"	DN2	3.56	97.0	4.03	110
	CMFS015M	1/6"	DN3	11.4	310	12.1	330
	CMFS025M	1/4"	DN6	41	1116	77.0	2100
	CMFS040M	3/8"	DN10	85.0	2,320	170	4,640
	CMFS050M	1/2"	DN15	133	3,614	250	6,820
	CMFS075M	3/4"	DN20	230	6,270	460	12,500
	CMFS100M	1"	DN25	534	14,524	950	25,900
	CMFS150M	1-1/2"	DN40	990	27,000	1,980	54,000
	CMF010M/L	1/10"	DN2	3.43	93.5	3.96	108
	CMF025M/L	1/4"	DN6	48.0	1,310	79.9	2,180
	CMF050M/L	1/2"	DN15	151	4,121	249	6,800
	CMF100M/L	1"	DN25	602	16,372	997	27,200
	CMF200M/L/A	2"	DN50	1,760	47,900	3,190	87,100
	CMF300M/L/A	3"	DN80	6,017	163,755	9,970	272,000
	CMF350M/A	4"	DN100	10,837	294,931	15,000	409,000
	CMF400M/A	4" to 6"	DN100- DN150	15,255	415,179	20,000	545,000
	CMFH2M/Y	6" to 8"	DN150- DN200	33,224	904,211	54,000	1,470,000
	CMFH3M/Y	8" to 10"	DN200- DN250	58,949	1,604,333	94,000	2,550,000
	CMFH4M	10" to 14"	DN250- DN350	87,799	2,389,527	120,000	3,266,000

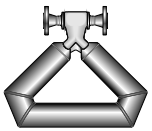
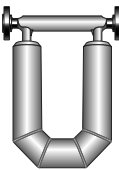
Mass flow rates for nickel alloy C22 (H/B) and high pressure (P) models



Style	Model	Nominal line size		Nominal flow rate		Maximum flow rate	
		inch	mm	lb/min	kg/h	lb/min	kg/h
	CMFS010H/P	1/10"	DN2	2.86	78.0	4.03	110
	CMFS015H/P	1/6"	DN3	8.18	223	12.1	330
	CMFS025H/P	1/4"	DN6	35.0	945	65.0	1,770
	CMFS050H/P	1/2"	DN15	100.0	2,720	188	5,130
	CMFS100H/P	1"	DN25	482	13,125	860	23,500
	CMFS150H/P	1-1/2"	DN40	900	24,500	1,800	49,100
	CMF010H/P	1/10"	DN2	2.57	70.2	3.96	108
	CMF025H	1/4"	DN6	48	1,310	79.9	2,180
	CMF050H	1/2"	DN15	151	4,121	249	6,800
	CMF100H	1"	DN25	602	16,372	997	27,200
	CMF200H/B	2"	DN50	1,760	47,900	3,190	87,100
	CMF300H/B	3"	DN75	6017	163,755	9,970	272,000
	CMF350P	4"	DN100	10,837	294,931	15,000	409,000
	CMF400H/B/P	4" - 6"	DN100- DN150	15,255	415,179	20,000	545,000

Volume flow rates for stainless steel models: 304L (L), 316L (M/A), and Super Duplex (Y)

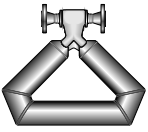
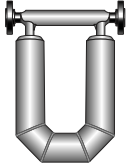
Style	Model	Nominal flow rate			Maximum flow rate		
		gal/min	barrels/h	l/h	gal/min	barrels/h	l/h
	CMFS007M	0.154	0.220	35.0	0.180	0.257	40.9
	CMFS010M	0.426	0.609	97.0	0.484	0.691	110
	CMFS015M	1.36	1.95	310	1.45	2.07	330
	CMFS025M	5	7	1,119	9.23	13.2	2,100
	CMFS040M	10.2	14.6	2,320	20.4	29.1	4,640
	CMFS050M	16.0	23	3,627	30.0	42.8	6,820
	CMFS075M	27.6	39.4	6,270	55.2	78.8	12,500
	CMFS100M	64.0	91.0	14,576	114	163	25,900
	CMFS150M	119	170	27,000	237	339	54,000

Style	Model	Nominal flow rate			Maximum flow rate		
		gal/min	barrels/h	l/h	gal/min	barrels/h	l/h
	CMF010M/L	0.411	0.587	93.5	0.475	0.678	108
	CMF025M/L	5.76	8.23	1,310	9.58	13.7	2,180
	CMF050M/L	18.0	26.0	4,136	29.9	42.7	6,800
	CMF100M/L	72.0	103.0	16,430	120	171	27,200
	CMF200M/L/A	211	301	47,900	383	547	87,100
	CMF300M/L/A	721	1,029	164,338	1,200	1,710	272,000
	CMF350M/A	1,298	1,852	295,981	1,800	2,570	409,000
	CMF400M/A	1,827	2,608	416,657	2,400	3,420	545,000
	CMFHC2M/Y	3,978	5679	907,429	6,440	9,200	1,470,000
	CMFHC3M/Y	7,059	10,077	1,610,044	11,270	16,100	2,550,000
	CMFHC4	10,514	15,008	2,398,033	14,350	20,500	3,266,000

Volume flow rates for nickel alloy C22 (H/B) and high pressure (P) models

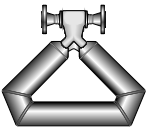
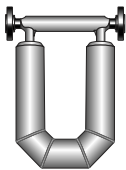
Style	Model	Nominal flow rate			Maximum flow rate		
		gal/min	barrels/h	l/h	gal/min	barrels/h	l/h
	CMFS010H/P	0.343	0.490	78.0	0.484	0.691	110
	CMFS015H/P	0.980	1.40	223	1.45	2.07	330
	CMFS025H/P	4	6	948	7.79	11.1	1,770
	CMFS050H/P	12	17	2,729	22.5	32.2	5,130
	CMFS100H/P	58	82	13,171	103	147	23,500
	CMFS150H/P	108	154	24,500	216	308	49,100
	CMF010H/P	0.309	0.441	70.2	0.475	0.678	108
	CMF025H	5.76	8.23	1,310	9.58	13.7	2,180
	CMF050H	18	26	4,136	29.9	42.7	6,800
	CMF100H	72	103	16,430	120	171	27,200
	CMF200H/B	211	301	47,900	383	547	87,100
	CMF300H/B	721	1,029	164,338	1,200	1,710	272,000
	CMF350P	1,298	1,852	295,981	1,800	2,570	409,000
	CMF400H/B/P	1,827	2,608	416,657	2,400	3,420	545,000

Gas flow rates

When selecting sensors for gas applications, pressure drop through the sensor is dependent upon operating temperature, pressure, and fluid composition. Therefore, when selecting a sensor for any particular gas application, it is highly recommended that each sensor be sized using the Sizing and Selection Tool at the Emerson web site (www.emerson.com/flowmeasurement).

The table below indicates mass flow rates that produce approximately 25 psig (1.7 barg) pressure drop on natural gas with molecular weight of 19.5 at 60 °F (16 °C) (16 °C) and 1,000 psig (69 barg) (34 barg).

Gas flow rates for all models

Model	Mass		Volume	
	lb/min	kg/h	SCFM	Nm ³ /h
CMFS007M	0.5	15	12	20
CMFS010M	1.1	30	24	42
CMFS010H/P	0.97	26	22	37
CMFS015M	2.7	76	62	106
CMFS015H/P	2.1	58	48	81
CMFS025M	9	240	200	340
CMFS025H/P	7.7	210	170	290
CMFS040M	19	540	440	750
CMFS050M	28	770	640	1,000
CMFS050H/P	21	590	490	830
CMFS075M	54	1,400	1,200	2,000
CMFS100M	100	2,900	2,400	4,100
CMFS100H/P	98	2,600	2,200	3,700
CMFS150M	220	6,100	5,000	8,500
CMFS150H/P	200	5,600	4,600	7,800
CMF010M/H/L	0.85	23	19	32
CMF010P	0.65	17	14	25
CMF025M/L/H	11	310	260	440
CMF050M/L/H	29	810	670	1,100
CMF100M/L/H	130	3,600	3,000	5,100
CMF200M/L/H/A/B	400	10,000	9,000	15,000
CMF300M/L/H/A/B	1,300	36,000	30,000	51,000
CMF350M/A/P	2,300	62,000	51,000	88,000
CMF400M/H/A/B/P	3,300	92,000	76,000	120,000
CMFHC2M/A/Y	5,500	150,000	120,000	210,000

Model	Mass		Volume	
	lb/min	kg/h	SCFM	Nm ³ /h
CMFHC3M/A/Y	8,800	240,000	200,000	330,000
CMFHC4M	14,000	380,000	320,000	540,000

Note

Standard (SCFM) reference conditions for natural gas with molecular weight of 17 are 14.7 psi (1.014 bar) and 60 °F (15.6 °C).

Zero stability

Zero stability is used when the flow rate approaches the low end of the flow range where the meter accuracy begins to deviate from the stated accuracy rating, as depicted in the turndown section. When operating at flow rates where meter accuracy begins to deviate from the stated accuracy rating, accuracy is governed by the formula: accuracy = (zero stability/flow rate) x 100%. Repeatability is similarly affected by low flow conditions.

Turndown

The graph and table below represent an example of the measurement characteristics under various flow conditions. At flow rates requiring large turndowns (greater than 20:1), the zero stability values may begin to govern capability dependent upon flow conditions and meter in use.

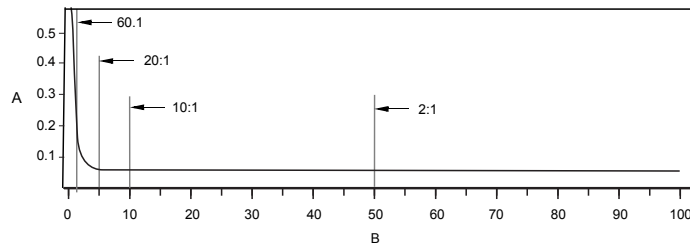

- A. Accuracy, %
- B. Flow rate, % of nominal

Sample of accuracy and pressure drop across flow rate

Turndown from nominal flow rate	60:1	20:1	10:1	2:1	1:1
Accuracy ±%	0.25	0.05	0.05	0.05	0.05
Pressure drop	0.008 psig (0.00055 barg)	0.06 psig (0.0041 barg)	0.22 psig (0.0152 barg)	4.11 psig (0.2834 barg)	14.5 psig (1.000 barg)

Zero stability for stainless steel models: 316L (M)

Model	Zero stability	
	lb/min	kg/h
CMFS007M	0.000043	0.0012
CMFS010M	0.000075	0.0020
CMFS015M	0.00030	0.0081

Model	Zero stability	
	lb/min	kg/h
CMFS025M	0.00065	0.017
CMFS040M	0.0018	0.05
CMFS050M	0.0026	0.07
CMFS075M	0.0071	0.19
CMFS100M	0.012	0.33
CMFS150M	0.030	0.81

Zero stability for stainless steel models: 304L (L), 316L (A), and Super Duplex (Y)

Model	Zero stability	
	lb/min	kg/h
CMF010M/L	0.000078	0.0021
CMF025M/L	0.00010	0.027
CMF050M/L	0.0029	0.078
CMF100M/L	0.017	0.47
CMF200M/L/A	0.048	1.30
CMF300M/L/A	0.16	4.40
CMF350M/A	0.31	8.30
CMF400M/A	0.72	19.71
CMFHC2M/Y/A	1.08	29.45
CMFHC3M/Y/A	2.34	63.56
CMFHC4M	3.66	99.65

Zero stability values for nickel alloy C22 models (H/B)

Model	Zero stability	
	lb/min	kg/h
CMFS010H	0.00016	0.0044
CMFS015H	0.00042	0.011
CMFS025H	0.0013	0.036
CMFS050H	0.0037	0.10
CMFS100H	0.012	0.32
CMFS150H	0.035	0.96

Model	Zero stability	
	lb/min	kg/h
CMF010H	0.000075	0.0021
CMF025H	0.00090	0.025
CMF050H	0.0041	0.11
CMF100H	0.014	0.37
CMF200H/B	0.07	1.97
CMF300H/B	0.17	4.57
CMF400H/B	0.74	20.20

Zero stability values for high pressure (P) models

Model	Zero stability	
	lb/min	kg/h
CMFS010P	0.00017	0.0045
CMFS015P	0.00044	0.012
CMFS025P	0.0011	0.031
CMFS050P	0.0043	0.12
CMFS100P	0.012	0.34
CMFS150P	0.030	0.82
CMF010P	0.00016	0.0043
CMF350P	0.32	8.75
CMF400P	0.74	20.07

Process pressure ratings

Sensor maximum working pressure reflects the highest possible pressure rating for a given sensor. Process connection type and environmental and process fluid temperatures may reduce the maximum rating. Refer to the Technical Data Sheet for common sensor and fitting combinations.

All sensors comply with Council Directive 2014/68/EU on pressure equipment.

Some sensor models also comply with the ASME B31.1 power piping design code as indicated with a pressure rating in the table. Sensors with JIS process connections do not comply with ASME B31.1 power piping code.

Sensor maximum working pressure for stainless steel models: 304L (L) and 316L (M/A)

Model	ASME B31.3 compliance		ASME B31.1 compliance	
	psig	barg	psig	barg
CMFS007M, CMFS010M	3,625	250	n/a	n/a

Model	ASME B31.3 compliance		ASME B31.1 compliance	
	psig	barg	psig	barg
CMFS015M	2,200	150	n/a	n/a
CMFS025M, CMFS040M, CMFS050M, CMFS075M, CMFS100M, CMFS150M	1,500	103	1,500	103
CMF010M/L	1,812	125	1,812	125
CMF025M/L, CMF050M/L	1,500	103	1,500	103
CMF100M/L	1,450	100	1,450	100
CMF200M/L/A	1,580	109	1,580	109
CMF300M/L/A	1,730	119	1,730	119
CMF350M/A	1,480	102	1,480	102
CMF400M/A	1,500	103	1,500	103
CMFHC2M/A	1,480	102	1470	101
CMFHC3M/A	1,480	102	1460	101
CMFHC4M	1,480	102	n/a	n/a

Sensor maximum working pressure for nickel alloy C22 models (H/B)

Model	ASME B31.3 compliance		ASME B31.1 compliance	
	psig	barg	psig	barg
CMFS010H, CMFS015H	6,000	414	n/a	n/a
CMFS025H, CMFS050H	3,626	250	3,626	250
CMFS100H, CMFS150H	3,626	250	n/a	n/a
CMF010H	3,263	225	n/a	n/a
CMF025H	2,755	190	n/a	n/a
CMF050H	2,683	185	n/a	n/a
CMF100H	2,465	170	n/a	n/a
CMF200H/B	2,755	190	n/a	n/a
CMF300H/B	2,683	185	n/a	n/a
CMF400H/B	2,855	197	n/a	n/a

Sensor maximum working pressure for high pressure models (P)

Model	ASME B31.3 compliance		ASME B31.1 compliance	
	psig	barg	psig	barg
CMFS010P, CMFS015P	6,000	414	n/a	n/a
CMFS025P, CMFS050P	3,626	250	3,626	250
CMFS100P, CMFS150P	3,626	250	n/a	n/a
CMF010P	6,000	414	n/a	n/a
CMF350P	2,250	155	n/a	n/a
CMF400P	2,973	205	n/a	n/a

Sensor maximum working pressure for Super Duplex models (Y)

Model	ASME B31.3 compliance		ASME B31.1 compliance	
	psig	barg	psig	barg
CMFHC2Y, CMFHC3Y	2,320	160	n/a	n/a

Case pressure

Case pressure for CMF models

Model	Case maximum pressure ⁽¹⁾		Typical burst pressure ⁽²⁾	
	psig	barg	psig	barg
CMF010	425	29	3,042	210
CMF025	850	59	5,480	378
CMF050	850	59	5,286	364
CMF100	625	43	3,299	227
CMF200	550	38	2,786	192
CMF300	275	19	1,568	108
CMF350	275	19	2,092	144
CMF400	250	17	1,556	107
CMFHC2	n/a	n/a	1,100	76
CMFHC3	n/a	n/a	1,150	79
CMFHC4	n/a	n/a	990	68

(1) Derived from B31.3 international standards.

(2) Values do not apply for high-temperature models (base model codes A or B).

Case pressure for CMFS models

Model	Case maximum pressure ⁽¹⁾		Typical burst pressure	
	psig	barg	psig	barg
CMFS007	1,326	91	5,302	365
CMFS010, CMFS015	1,518	105	6,072	419
CMFS025, CMFS040, CMFS050	558	39	2,230	154
CMFS075, CMFS100, CMFS150	650	45	2,598	180

(1) Case maximum pressure is determined by applying a safety factor of 4 to typical burst pressure.

Operating conditions: Environmental

Vibration limits

Meets IEC 60068-2-6, endurance sweep, 5 to 2000 Hz, 50 sweep cycles at 1.0 g.

Temperature limits

Sensors can be used in the process and ambient temperature ranges shown in the temperature limit graphs. For the purposes of selecting electronics options, temperature limit graphs should be used only as a general guide. If your process conditions are close to the gray area, consult with your Micro Motion representative.

Note

- In all cases, the electronics cannot be operated where the ambient temperature is below -40 °F (-40.0 °C) or above 140 °F (60.0 °C). If a sensor is to be used where the ambient temperature is outside of the range permissible for the electronics, the electronics must be remotely located where the ambient temperature is within the permissible range, as indicated by the shaded areas of the temperature limit graphs.
- Temperature limits may be further restricted by hazardous area approvals. Refer to the hazardous area approvals documentation shipped with the sensor or available at www.emerson.com/flowmeasurement.
- The extended-mount electronics option allows the sensor case to be insulated without covering the transmitter, core processor, or junction box, but does not affect temperature ratings. When insulating the sensor case at elevated process temperatures (above 140 °F (60.0 °C)), please ensure electronics are not enclosed in insulation as this may lead to electronics failure.
- For the CMFS007 sensor, the difference between the process fluid temperature and the average temperature of the case must be less than 210 °F (98.9 °C)

Ambient and process temperature limits for ELITE CMFS007, CMFS025–CMFS150 meters

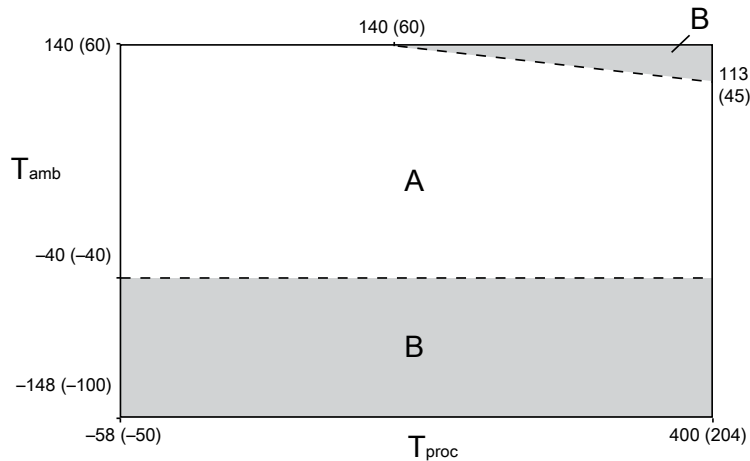

T_{amb} = Ambient temperature °F (°C)
 T_{proc} = Process temperature °F (°C)
 A = All available electronic options
 B = Remote mount electronics only

Ambient and process temperature limits for ELITE CMF*M/L/H/P (excludes special order cryogenic modifications) and CMFS010-015 meters**

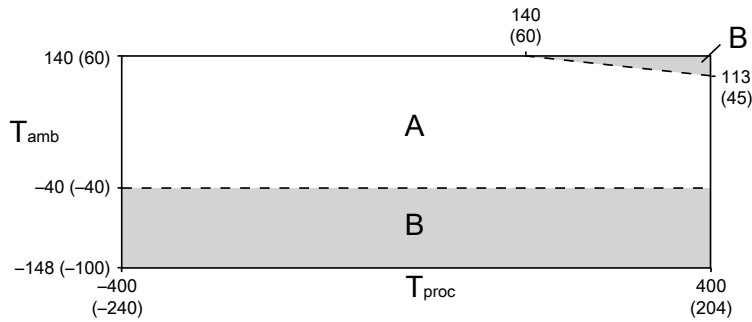

T_{amb} = Ambient temperature °F (°C)
 T_{proc} = Process temperature °F (°C)
 A = All available electronic options
 B = Remote mount electronics only

Ambient and process temperature limits for special order cryogenic ELITE meters

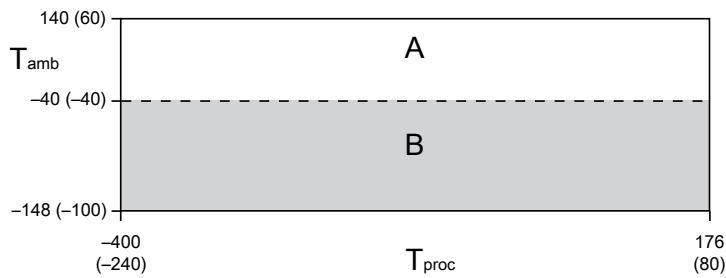

T_{amb} = Ambient temperature °F (°C)
 T_{proc} = Process temperature °F (°C)
 A = All available electronic options
 B = Remote mount electronics only

Ambient and process temperature limits for high temperature ELITE meters

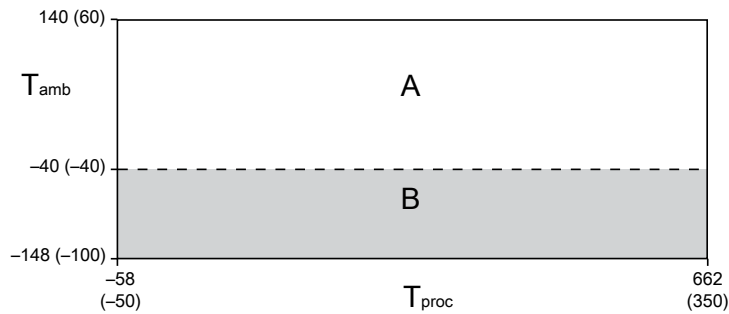

T_{amb} = Ambient temperature °F (°C)
 T_{proc} = Process temperature °F (°C)
 A = All available electronic options
 B = Remote mount electronics only

Ambient and process temperature limits for Super Duplex ELITE meters

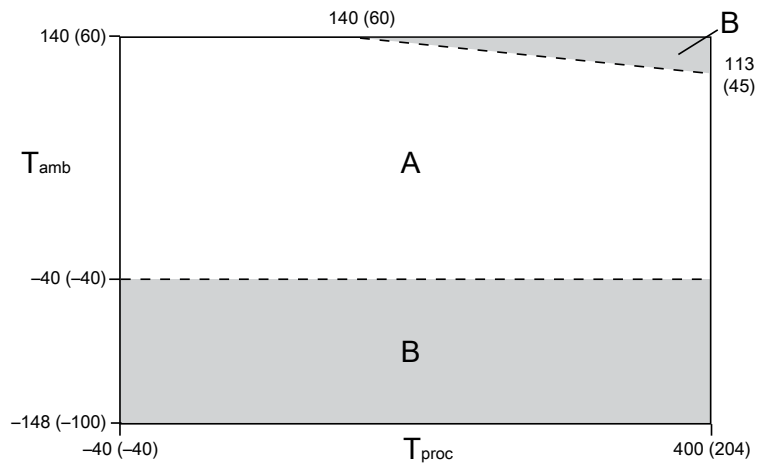

T_{amb} = Ambient temperature °F (°C)

T_{proc} = Process temperature °F (°C)

A = All available electronic options

B = Remote mount electronics only

Note

For Super Duplex models operating above 351 °F (177.2 °C), please consult the factory before purchase.

Operating conditions: Process

Process temperature effect

- For mass flow measurement, process temperature effect is defined as the change in sensor flow accuracy specification due to process temperature change away from the calibration temperature. Use the Zero Verification and Smart Meter Verification tools to correct for any process temperature effect.
- For density measurement, process temperature effect is defined as the change in density accuracy specification due to process temperature change away from the calibration temperature.
 - For all models, process temperature effect on density is $\pm 0.000015 \text{ g/cm}^3$ ($\pm 0.015 \text{ kg/m}^3$) per $^\circ\text{C}$ difference from calibration temperature.
 - For models ordered with optional temperature calibration, density specification is valid from 0-60 $^\circ\text{C}$ and process temperature effect should be considered when operating above or below this range.

Flow process temperature effect for all models

Table 1:

Model	% of maximum mass flow rate per $^\circ\text{C}$
CMF010, CMFS007, CMFS010, CMFS015	± 0.0002
CMF025, CMF050, CMF100, CMFS025, CMFS040, CMFS050, CMFS075, CMFS100, CMFS150	± 0.0001
CMF200, CMF300	± 0.0005
CMF350, CMF400	± 0.0008
CMFHC2, CMFHC3, CMFHC4	± 0.000075

Process pressure effect

Process pressure effect is defined as the change in sensor mass flow and density accuracy specification due to process pressure change away from the calibration pressure. This effect can be corrected by dynamic pressure input or a fixed meter factor. Please refer to the calibration sheet for the specific meter pressure compensation coefficient. If no pressure compensation coefficient is provided, use the typical values listed in the table below. See installation manual for proper setup and configuration.

Process pressure effect for CMFS models

Model	Mass Flow (% of rate)		Density	
	per psi	per bar	g/cm^3 per psi	kg/m^3 per bar
CMFS007, CMFS010, CMFS015	none	none	none	none
CMFS025	none	none	-0.000004	-0.054
CMFS040	-0.0003	-0.005	-0.0000131	-0.187
CMFS050 M	-0.001	-0.015	-0.0000247	-0.358
CMFS050 H/P	none	none	-0.0000034	-0.049
CMFS075	-0.0007	-0.010	-0.0000255	-0.370
CMFS100 M	-0.0015	-0.021	-0.0000276	-0.400

Model	Mass Flow (% of rate)		Density	
	per psi	per bar	g/cm ³ per psi	kg/m ³ per bar
CMFS100 H/P	-0.0003	-0.005	-0.0000132	-0.191
CMFS150M	-0.0014	-0.020	-0.000010	-0.145
CMFS150H/P	-0.0004	-0.006	-0.0000062	-0.090

Process pressure effect for CMF and CMFHC models

Model	Liquid flow (% of rate)		Gas flow (% of rate)		Density	
	per psi	per bar	per psi	per bar	g/cm ³ per psi	kg/m ³ per bar
CMF010	none	none	none	none	none	none
CMF025	none	none	none	none	0.0000040	0.0580
CMF050	none	none	none	none	-0.0000020	-0.0290
CMF100	-0.0002	-0.003	-0.0002	-0.003	-0.0000060	-0.0870
CMF200 M/A/L	-0.00062	-0.009	-0.00062	-0.009	0.0000010	0.0145
CMF200 H/B	-0.00055	-0.008	-0.00055	-0.008	0.000001	0.0145
CMF300 M/A/L	-0.0006	-0.009	-0.0006	-0.009	0.0000002	0.0029
CMF300 H/B	-0.0004	-0.006	-0.0004	-0.006	0.0000002	0.0029
CMF350	-0.0016	-0.023	-0.0016	-0.023	-0.000009	-0.1305
CMF400 M/A	-0.0011	-0.016	-0.0011	-0.016	-0.00001	-0.1450
CMF400 H/B/P	-0.0008	-0.012	-0.0008	-0.012	-0.00001	-0.1450
CMFHC2	-0.0016	-0.023	-0.0016	-0.023	-0.0000028	-0.0406
CMFHC3	-0.0010	-0.015	-0.0010	-0.015	-0.0000025	-0.0363
CMFHC4	-0.0014	-0.020	-0.0014	-0.020	-0.0000014	-0.0203

Pressure relief

ELITE sensors are available with a rupture disk installed on the case. Rupture disks are meant to vent process fluid from the sensor case in the unlikely event of a flow tube breach. Some users connect a pipeline to the rupture disk to help contain escaping process fluid. For more information about rupture disks, contact Micro Motion Customer Service.

If the sensor has a rupture disk, it should remain installed at all times as it would otherwise be necessary to re-purge the case. If the rupture disk is activated by a tube breach, the seal in the rupture disk will be broken, and the Coriolis meter should be removed from service.

The rupture disk is located as follows on the meter, and the warning sticker shown is placed next to it.

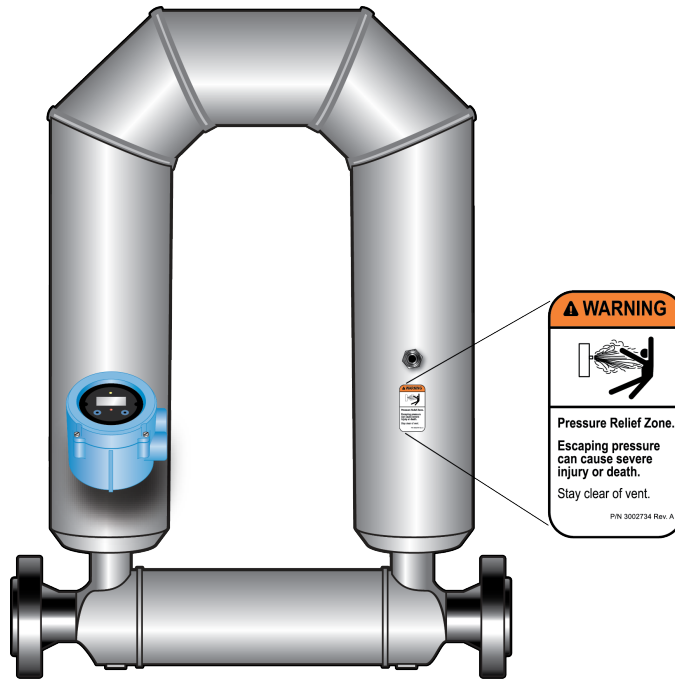

! DANGER

Stay clear of the rupture disk pressure relief area. High-pressure fluid escaping from the sensor can cause severe injury or death.

The sensor must be oriented so that personnel and equipment will not be exposed to any discharge along the pressure relief path.

Important



If a rupture disk is used, the housing can no longer assume a secondary containment function.

! WARNING

Removing the Purge Fitting, Blind Plug, or Rupture Disks compromises the Ex-i Safety Certification, the Ex-tc Safety Certification, and the IP-rating of the Coriolis meter. Any modification to the Purge Fitting, Blind Plug, or Rupture Disks must maintain a minimum of IP66/IP67 Ratings.

Hazardous area classifications

Approvals and certifications

Type	Approval or certification (typical)	
CSA and CSA C-US	Ambient temperature: -40 to +140 °F (-40 to +60 °C) Class I, Div. 1, Groups C and D Class I, Div. 2, Groups A, B, C, and D. Class II, Div.1, Groups E, F, and G.	
ATEX		II 2G Ex ib IIB/IIC T1-T4/T5/T6 Gb II 2D Ex ib IIIC T(1)°C Db IP66
		II 3G Ex nA IIC T1-T4/T5 Gc II 3D Ex tc IIIC T(1) °C Dc IP66
IECEX	Ex ib IIB/IIC T1-T4/T5/T6 Gb Ex nA IIC T1-T4/T5 Gc	
NEPSI	Ex ib IIB/IIC T1-T6 Gb Ex ibD 21 T450°C-T85°C Ex nA IIC T1-T6 Gc DIP A22 T(1) T1-T6	
Ingress Protection Rating	IP 66/67 for sensors and transmitters	
EMC effects	Complies with EMC directive 2004/108/EC per EN 61326 Industrial	
	Complies with NAMUR NE-21 (22.08.2007)	

Note

For complete details on hazardous area classifications availability by model code, please use the *Micro Motion ELITE Technical Data Sheet* at <https://www.emerson.com/documents/automation/technical-data-sheet-elite-series-coriolis-flow-density-meters-en-64390.pdf>.

Marine approval classifications

For models CMF200M, CMF300M, CMF350M, CMF400M, CMFHC2M, CMFHC3M, CMFHC4M.

Marine approval	Country
Lloyd’s Register ENV1, ENV2, ENV3, ENV5	United Kingdom
Det Norske Veritas- Germanischer Lloyd	Norway-Germany
Bureau Veritas	France
American Bureau of Shipping	USA
Nippon Kaiji Kyokai	Japan

For models CMFS010H, CMFS015H, CMFS025H, CMFS050H, CMFS100H, CMFS150H.

Marine approval	Country
Lloyd’s Register ENV1, ENV2, ENV3, ENV5	United Kingdom

Marine approval	Country
Det Norske Veritas- Germanischer Lloyd	Norway-Germany

Industry standards

Type	Standard
Weights and Measures for custody transfer applications:	<ul style="list-style-type: none"> ■ MID OIML R117/R137 ■ National Type Evaluation Program (NTEP) ■ Measurement Canada ■ INMETRO Brazil
Hygienic approvals (some models)	<ul style="list-style-type: none"> ■ ASME BPE ■ EHEDG, 3A
Industry standards and commercial approvals	<ul style="list-style-type: none"> ■ NAMUR: NE132 (burst pressure, sensor flange to flange length), NE131 ■ Pressure Equipment Directive (PED) ■ Canadian Registration Number (CRN) ■ Dual Seal ■ ASME B31.1 power piping code and ASME B31.3 process piping code ■ SIL2 and SIL3 safety certifications ■ All Super Duplex materials comply with NORSOK M-650

Note

- Approvals shown are for ELITE meters configured with a core processor for remote 4-wire connection to a Micro Motion transmitter. Meters with integral electronics may have more restrictive approvals. Refer to the Product Data Sheet for each transmitter for details.
- When a meter is ordered with hazardous area approvals, detailed information is shipped along with the product.
- More information about hazardous approvals, including detailed specifications and temperature graphs for all meter configurations is available on the ELITE Series product page at the Micro Motion web site (www.emerson.com).

Transmitter interface

A Micro Motion flowmeter system is highly customizable to provide a configuration that is tailor-fit to specific applications.

Robust transmitter offerings allow a multitude of mounting options:

- Compact mounting integral to the sensor
- Field mount variants for harsh conditions
- Compact control room DIN rail packages for optimal locating in a control cabinet
- Specific fit-for-purpose solutions for two-wire connectivity or filling and dosing machinery integration

Micro Motion meters are available with an expansive selection of input and output connectivity options including the following:

- 4-20 mA
- HART™
- WirelessHART™
- DeviceNet
- EtherNet/IP
- Profinet
- FOUNDATION™ fieldbus
- PROFIBUS
- Modbus®
- Other protocols may be available on request

Physical specifications

Materials of construction

General corrosion guidelines do not account for cyclical stress, and therefore should not be relied upon when choosing a wetted material for your Micro Motion meter. Please refer to the *Micro Motion Corrosion Guide* for material compatibility information.

Wetted part materials

Model	Stainless steel			Nickel alloy C22	Super Duplex	Sensor only weight	
	316L	316L 32Ra	304L			lb	kg
CMFS007	•					10	5
CMFS010	•	•		•		10	5
CMFS015	•	•		•		10	5
CMFS025	•			•		19	9
CMFS040	•					19	9
CMFS050	•			•		19	9
CMFS075	•					30	14
CMFS100	•			•		30	14
CMFS150	•			•		30	14
CMF010	•		•	•		17	8
CMF025	•		•	•		9	4
CMF050	•		•	•		14	6
CMF100	•		•	•		31	14
CMF200	•		•	•		66	30
CMF300	•		•	•		180	81
CMF350	•			•		240	109
CMF400	•			•		440	200
CMFHC2	•				•	610	280
CMFHC3	•				•	770	350
CHFHC4	•					1,390	630

Note

- Weight specifications are based upon ASME B16.5 CL 150 flange and do not include electronics.
- Heat jackets and steam kits are also available.

Table 2: Non-wetted part materials

Component	Enclosure rating	316L/CF-3M stainless steel	300 series stainless steel	Polyurethane-painted aluminum
Sensor housing	—	Optional for CMFS models	•	
Core processor housing	NEMA 4X (IP66/67)	•		•
Junction box	NEMA 4X (IP66)	•		•
Model 1700/2700 transmitter housing	NEMA 4X (IP66)	•		•
Model 3700 transmitter housing	NEMA 4X (IP66/67)			•
Model 2400S transmitter housing	NEMA 4X (IP66/67)	•		•
Model 2200S transmitter housing	NEMA 4X (IP66/67)	•		•
Model FMT transmitter housing	NEMA 4X (IP66/67)	Optional for 32 or 64 Ra		

Flanges

Sensor type	Flange types
Stainless steel 316L & cryogenic	<ul style="list-style-type: none"> ■ ASME B16.5 weld neck flange (up to CL600) ■ ASME B16.5 weld neck flange RTJ face (up to CL600) ■ ASME B16.5 weld neck flange raised face (up to CL600) ■ ASME B16.5 wafer style ■ EN 1092-1 weld neck flange Type B1, B2, C, D, E, N (up to PN100) ■ JIS B2220 weld neck raised face (up to 20K) ■ VCO, VCR Swagelok compatible fitting (VCO fittings include the Viton o-ring as a wetted part) ■ Hygienic tri-clamp compatible
Nickel alloy C22	<ul style="list-style-type: none"> ■ ASME B16.5 lap joint flange (up to CL900/1500) ■ EN 1092-1 lap joint flange Type B, D (up to PN160) ■ JIS B2220 lap joint flange (up to 20K)
Nickel alloy C22/316L stainless steel	<ul style="list-style-type: none"> ■ ASME B16.5 weld neck flange (up to CL2500) ■ VCO swagelok compatible fitting ■ EN 1092-1 weld neck flange Type B, D (up to PN250) ■ Hygienic tri-clamp compatible
Hygienic	<ul style="list-style-type: none"> ■ Hygienic fittings (tri-clamp ASME BPE) ■ Hygienic couplings (DIN11864-1A/2A/3A; DIN11851; ISO 2852/DIN 11850; ISO 2852/ISO 1127; SMS 1145)

Note

For flange compatibility, please refer to the Sizing and Selection Tool at the Emerson web site (www.emerson.com/flowmeasurement).

Dimensions

These dimensional drawings are intended to provide a basic guideline for sizing and planning. They are representative of a 316 stainless steel model fitted with ASME B16.5 CL 150 flange, and 2400 or 5700 transmitter.

Face-to-Face dimensions for ELITE meters with each available process connection can be found in the *Micro Motion ELITE Coriolis Flow and Density Meters Technical Data Sheet* at <https://www.emerson.com/documents/automation/technical-data-sheet-elite-series-coriolis-flow-density-meters-en-64390.pdf>.

Complete and detailed dimensional drawings can be found through the product drawings link (refer to www.emerson.com/flowmeasurement).

Note

- Accuracy: $\pm 1/8$ inch (± 3 mm)
- Representative of a 316 stainless steel model fitted with ASME B16.5 CL 150 flange, and 2400 or 5700 transmitter

Example dimensions for CMFS models

Note

For full dimensional details, refer to the *Micro Motion ELITE Coriolis Flow and Density Meters Technical Data Sheet*.

Figure 1: CMFS 007, 010, and 015 models

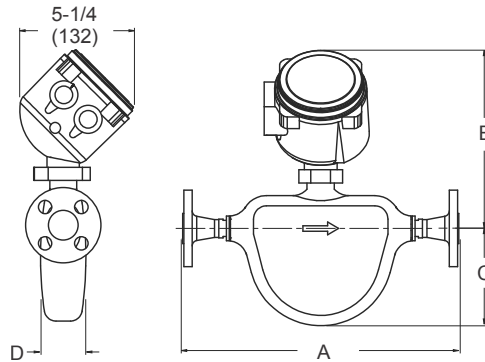
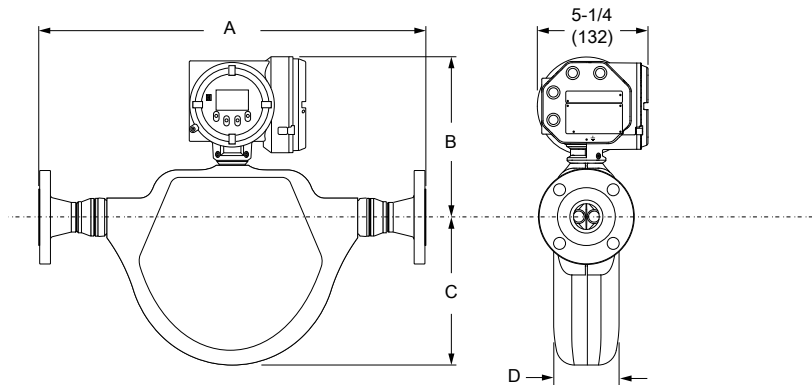

Figure 2: CMFS 025, 040, 050, 075, 100, and 150 models



Note

For full dimensional details, refer to the ELITE Technical Data Sheet.

Model	Dim. A ASME B16.5 CL150		Dim. B		Dim. C		Dim. D	
	Inch	mm	Inch	mm	Inch	mm	Inch	mm
CMFS007M, CMFS010M, CMFS015M	12-5/8	321	8-1/8	207	4-7/16	113	2-1/8	54
CMFS025M, CMFS040M, CMFS050M	19-7/16	494	9-7/16	240	7-7/16	189	3-1/4	82
CMFS075M, CMFS100M, CMFS150M	23-1/2	598	10-1/16	256	9-1/2	241	4	102

Example dimensions for CMF010 through CMF100 models

Note

For full dimensional details, refer to the *Micro Motion ELITE Coriolis Flow and Density Meters Technical Data Sheet*.

Figure 3: CMF010 model

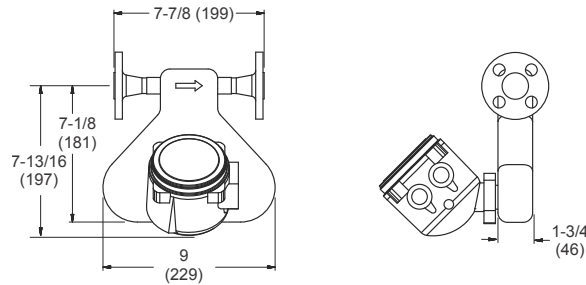
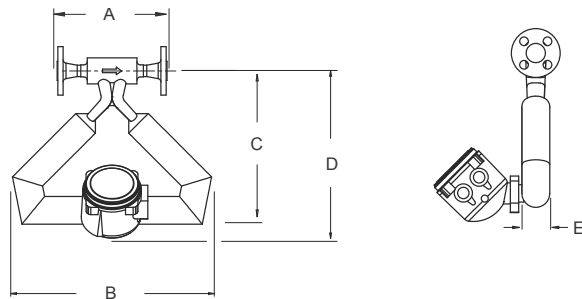

Figure 4: CMF025 through CMF100 models



Note

For full dimensional details, refer to the *Micro Motion ELITE Coriolis Flow and Density Meters Technical Data Sheet*.

Note

- Accuracy: ±1/8 inch (±3 mm)
- Representative of a 316 stainless steel model fitted with ASME B16.5 CL 150 flange, and 2400 transmitter

Model	Dim. A ASME B16.5 CL150		Dim. B		Dim. C		Dim. D		Dim. E	
	Inch	mm	Inch	mm	Inch	mm	Inch	mm	Inch	mm
CMF010M	7-7/8	199	9	229	7-1/8	181	7-13/16	197	1-3/4	46
CMF025M	6-3/4	171	10	254	8-1/4	210	9-7/16	238	1-5/8	42
CMF050M	7-15/16	202	14-3/8	365	11-1/16	281	12-1/16	305	2	52
CMF100M	9-1/4	235	21-1/2	546	16	406	16-3/16	410	3-5/8	90

Example dimensions for CMF200 through CMFHC4 models

Note

For full dimensional details, refer to the *Micro Motion ELITE Coriolis Flow and Density Meters Technical Data Sheet*.

Figure 5: CMF200 through CMFHC4 models

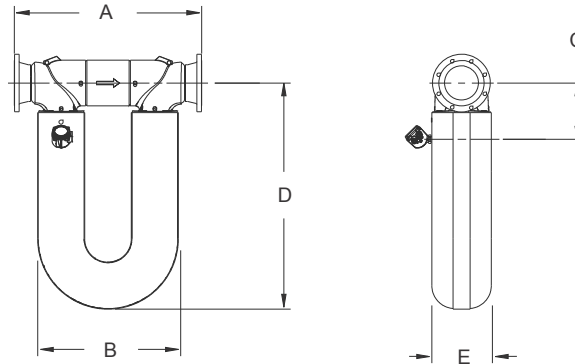

Note

- Accuracy: ±1/8 inch (±3 mm)
- Representative of a 316 stainless steel model fitted with ASME B16.5 CL 150 flange, and 2400 transmitter

Model	Dim. A ASME B16.5 CL150		Dim. B		Dim. C		Dim. D		Dim. E	
	Inch	mm	Inch	mm	Inch	mm	Inch	mm	Inch	mm
CMF200M	22-7/8	581	19-5/8	498	6-7/8	174	28-5/8	727	5-5/8	144
CMF300M	33-11/16	856	30-3/16	767	9-5/16	236	38-7/16	976	8-1/4	208
CMF350M	37-1/4	946	28-5/16	720	12-1/4	310	32-13/16	833	8-3/8	212
CMF400M	40-3/16	1021	32-3/4	832	12-3/8	314	38-1/8	968	10-3/4	274
CMFHC2M	42-3/4	1087	33	838	12-5/16	313	48-5/8	1235	12-3/4	324
CMFHC3M	43-3/4	1111	33	838	13-3/16	335	53-3/16	1350	14	354
CMFHC4M	47-3/4	1213	33	838	14-1/8	358	65-1/2	1664	17-3/4	452

Ordering information

Model code structure

A complete sensor model code includes the ordering options.

Example code	Description
CMFS	Sensor series
025	Sensor size
M	Base model
313	Process connections
N	Case and hygienic options
0	Electronics interface
A	Conduit connections
M	Approvals
E	Languages
Z	Calibration
Z	Measurement application software
Z	Factory options

Base model

Code descriptions

Codes M, L, H, Y, P, A, and B are model designations used to identify the type of meter.

Code	Material
M	316L stainless steel
L	304L stainless steel
H	Nickel alloy C22
Y	Super Duplex (UNS S32750)
P	Nickel alloy C22/316L stainless steel
A	High temperature 316L stainless steel
B	High temperature nickel alloy C22

Codes available by model

Model	Available codes						
	M	L	H	Y	P	B	A
CMFS007 – 1/12" (DN1)	M						
CMFS010 – 1/10" (DN2)	M		H		P		
CMFS015 – 1/6" (DN3)	M		H		P		
CMFS025 – 1/4" (DN6)	M		H		P		
CMFS040 – 3/8" (DN10)	M						
CMFS050 – 1/2" (DN15)	M		H		P		
CMFS075 – 3/4" (DN20)	M						
CMFS100 – 1" (DN25)	M		H		P		
CMFS150 – 1-1/2" (DN40)	M		H		P		
CMF010 – 1/10" (DN2)	M	L	H		P		
CMF025 – 1/4" (DN6)	M	L	H				
CMF050 – 1/2" (DN15)	M	L	H				
CMF100 – 1" (DN25)	M	L	H				
CMF200 – 2" (DN50)	M	L	H			B	A
CMF300 – 3" (DN80)	M	L	H			B	A
CMF350 – 4" (DN100)	M				P		A
CMF400: 4" - 6" (DN100-DN150)	M		H		P	B	A
CMFHC2: 6" - 8" (DN150-DN200)	M			Y			A
CMFHC3: 8" - 10" (DN200-DN250)	M			Y			A
CMFHC4: 10" - 14" (DN250-DN350)	M						

Process connections

Model CMFS010H and Model CMFS015H (nickel alloy C22)

Code	Description					
323	#4		VCO	N06022	Swagelok compatible fitting	1/4" N10276 NPT female adapter
334	#4		VCO	N06022	Swagelok compatible fitting	
520	1/2-inch	CL150	ASME B16.5	F304/F304L	Lap joint flange	N06022 stub
521	1/2-inch	CL300	ASME B16.5	F304/F304L	Lap joint flange	N06022 stub

Code	Description					
522	15mm	10K	JIS B 2220	F304/F304L	Lap joint flange	N06022 stub
523	DN15	PN40	DIN 2656	F304/F304L	Lap joint flange	Form C face, N06022 stub
524	DN15	PN40	EN 1092-1	F304/F304L	Lap joint flange	Type B1, N06022 stub

Model CMFS007M, CMFS010M, and CMFS015M (316L stainless steel)

Code	Description					
172	DN25	PN40	EN 1092-1	F316/F316L	Weld neck flange	Type B1
176	DN15	PN40	EN 1092-1	F316/F316L	Weld neck flange	Type B1
177	DN15	PN100	EN 1092-1	F316/F316L	Weld neck flange	Type B2
178	DN15	PN100	EN 1092-1	F316/F316L	Weld neck flange	Type D
183	DN25	PN40	EN 1092-1	F316/F316L	Weld neck flange	Type D
300	15mm	PN40	DIN 2635	F316/F316L	Weld neck flange	Type C
301	15mm	PN40	DIN 2635	F316/F316L	Weld neck flange	Type N
302	15mm	PN100	DIN 2635	F316/F316L	Weld neck flange	Type E
303	15mm	PN100	DIN 2635	F316/F316L	Weld neck flange	Type N
304	15mm	10K	JIS B 2220	F316/F316L	Weld neck flange	Raised face
305	15mm	20K	JIS B 2220	F316/F316L	Weld neck flange	Raised face
310	DN15	PN40	EN 1092-1	F316/F316L	Weld neck flange	Type D
313	1/2"	CL150	ASME B16.5	F316/F316L	Weld neck flange	Raised face
314	1/2"	CL300	ASME B16.5	F316/F316L	Weld neck flange	Raised face
315	1/2"	CL600	ASME B16.5	F316/F316L	Weld neck flange	Raised face
319	#8		VCO	316/316L	Swagelok compatible fitting	1/2" 316 NPT female adapter
321 ⁽¹⁾	1/2"		Tri-Clamp compatible	316L	Hygienic fitting	
323	#4		VCO	316/316L	Swagelok compatible fitting	1/4" NPT female adapter
324	#4		VCO	316/316L	Swagelok compatible fitting	1/4" tube compression fitting adapter
325	#4		VCO	316/316L	Swagelok compatible fitting	6mm tube compression fitting adapter
334	#4		VCO	316/316L	Swagelok compatible fitting	
335	#8		VCO	316/316L	Swagelok compatible fitting	
344 ⁽²⁾⁽³⁾	3/4"		Tri-Clamp compatible	316L	Hygienic fitting	

Code	Description					
345 ⁽²⁾ (3)	DN10		ISO 2852/ISO 1127 tube	316L	Hygienic fitting	
346 ⁽²⁾ (3)	DN15		ISO 2852/DIN 11850 tube	316L	Hygienic fitting	

(1) Sensor is 3A authorized but not EHEDG certified when ordered with this fitting code.

(2) Sensor is 3A authorized and EHEDG certified when ordered with this fitting code. Only available with case and hygienic code H or T.

(3) Process connections 344, 345, 346 are not available for model CMFS007 sensors.

Model CMFS010P and Model CMFS015P (nickel alloy C22/316L stainless steel)

Code	Description					
150	1/2"	CL900/1500	ASME B16.5	F316/F316L	Weld neck flange	Raised face
191	1/2"	CL2500	ASME B16.5	F316/F316L	Weld neck flange	Raised face
319	#8		VCO	316/316L	Swagelok compatible fitting	1/2" 316 NPT female adapter
323	#4		VCO	316/316L	Swagelok compatible fitting	1/4" NPT female adapter
324	#4		VCO	316/316L	Swagelok compatible fitting	1/4" tube compression fitting adapter
325	#4		VCO	316/316L	Swagelok compatible fitting	6 mm tube compression fitting adapter
334	#4		VCO	316/316L	Swagelok compatible fitting	
335	#8		VCO	316/316L	Swagelok compatible fitting	

Model CMFS025H and CMFS050H (nickel alloy C22)

Code	Description					
520	1/2-inch	CL150	ASME B16.5	F304/F304L	Lap joint flange	N06022 stub
521	1/2-inch	CL300	ASME B16.5	F304/F304L	Lap joint flange	N06022 stub
524	DN15	PN40	EN 1092-1	F304/F304L	Lap joint flange	Type B1, N06022 stub

Model CMFS025M, CMFS040M, and CMFS050M (316L stainless steel)

Code	Description					
172	DN25	PN40	EN 1092-1	F316/F316L	Weld neck flange	Type B1
176	DN15	PN40	EN 1092-1	F316/F316L	Weld neck flange	Type B1
177	DN15	PN100	EN 1092-1	F316/F316L	Weld neck flange	Type B2
178	DN15	PN100	EN 1092-1	F316/F316L	Weld neck flange	Type D
183	DN25	PN40	EN 1092-1	F316/F316L	Weld neck flange	Type D
304	15mm	10K	JIS B 2220	F316/F316L	Weld neck flange	Raised face

Code	Description					
305	15mm	20K	JIS B 2220	F316/F316L	Weld neck flange	Raised face
310	DN15	PN40	EN 1092-1	F316/F316L	Weld neck flange	Type D
313	1/2"	CL150	ASME B16.5	F316/F316L	Weld neck flange	Raised face
314	1/2"	CL300	ASME B16.5	F316/F316L	Weld neck flange	Raised face
315	1/2"	CL600	ASME B16.5	F316/F316L	Weld neck flange	Raised face
319	#8		VCO	316/316L	Swagelok compatible fitting	1/2" 316 NPT female adapter
321	1/2"	Tri-Clamp compatible	ASME BPE	316L	Hygienic fitting	
322	3/4"	Tri-Clamp compatible	ASME BPE	316L	Hygienic fitting	
335	#8		VCO	316/316L	Swagelok compatible fitting	
336 ⁽¹⁾	#12		VCO	316/316L	Swagelok compatible fitting	
339	1"	Tri-Clamp compatible	ASME BPE	316L	Hygienic fitting	

(1) Only available on model CMFS050.

Model CMFS025P and CMFS050P (nickel alloy C22/316L stainless steel)

Code	Description					
150	1/2"	CL900/1500	ASME B16.5	F316/F316L	Weld neck flange	Raised face
170	DN15	PN100/160	EN 1092-1	F316/F316L	Weld neck flange	Type B2
184	DN15	PN250	EN 1092-1	F316/F316L	Weld neck flange	Type B2
319	#8		VCO	316/316L	Swagelok compatible fitting	1/2" 316 NPT female adapter
335	#8		VCO	316/316L	Swagelok compatible fitting	
336 ⁽¹⁾	#12		VCO	316/316L	Swagelok compatible fitting	

(1) Only available on model CMFS050.

Model CMFS075M, CMFS100M, and CMFS150M (316L stainless steel)

Code	Description					
179	DN25	PN40	EN 1092-1	F316/F316L	Weld neck flange	Type B1
180	DN25	PN100	EN 1092-1	F316/F316L	Weld neck flange	Type B2
181	DN25	PN100	EN 1092-1	F316/F316L	Weld neck flange	Type D
311	DN25	PN40	EN 1092-1	F316/F316L	Weld neck flange	Type D
316	DN50	PN40	EN 1092-1	F316/F316L	Weld neck flange	Type D
317	25mm	10K	JIS B 2220	F316/F316L	Weld neck flange	Raised face

Code	Description					
318	25mm	20K	JIS B 2220	F316/F316L	Weld neck flange	Raised face
322 ⁽¹⁾	3/4"	Tri-Clamp compatible	ASME BPE	316L	Hygienic fitting	
328	1"	CL150	ASME B16.5	F316/F316L	Weld neck flange	Raised face
329	1"	CL300	ASME B16.5	F316/F316L	Weld neck flange	Raised face
330	1"	CL600	ASME B16.5	F316/F316L	Weld neck flange	Raised face
331	1-1/2-inch	CL600	ASME B16.5	F316/F316L	Weld neck flange	Raised face
336 ⁽²⁾	#12		VCO	316/316L	Swagelok compatible fitting	
339 ⁽¹⁾	1"		Tri-Clamp compatible	316L	Hygienic fitting	
341	1-1/2-inch	CL150	ASME B16.5	F316/F316L	Weld neck flange	Raised face
342	1-1/2-inch	CL300	ASME B16.5	F316/F316L	Weld neck flange	Raised face
351	1-1/2-inch	Tri-Clamp compatible	ASME BPE	316L	Hygienic fitting	
352	2-inch	Tri-Clamp compatible	ASME BPE	316L	Hygienic fitting	
363	DN40	PN100	EN 1092-1	F316/F316L	Weld neck flange	Type B2
365	DN50	PN100	EN 1092-1	F316/F316L	Weld neck flange	Type B2
366	DN40	PN100	EN 1092-1	F316/F316L	Weld neck flange	Type D
368	DN40	PN40	EN 1092-1	F316/F316L	Weld neck flange	Type B1
369	DN50	PN40	EN 1092-1	F316/F316L	Weld neck flange	Type B1
385	40mm	10K	JIS B 2220	F316/F316L	Weld neck flange	Raised face
387	40mm	20K	JIS B 2220	F316/F316L	Weld neck flange	Raised face
418	2-inch	CL150	ASME B16.5	F316/F316L	Weld neck flange	Raised face
419	2-inch	CL300	ASME B16.5	F316/F316L	Weld neck flange	Raised face
420	2-inch	CL600	ASME B16.5	F316/F316L	Weld neck flange	Raised face

(1) Not available on model CMFS150.

(2) Only available on model CMFS075.

Model CMFS100H and CMFS150H (nickel alloy C22)

Code	Description					
530 ⁽¹⁾	1-inch	CL150	ASME B16.5	F304/F304L	Lap joint flange	N06022 stub
531 ⁽¹⁾	1-inch	CL300	ASME B16.5	F304/F304L	Lap joint flange	N06022 stub

Code	Description					
534 ⁽¹⁾	DN25	PN40	EN 1092-1	F304/F304L	Lap joint flange	Type B1, N06022 stub
540	1-1/2"	CL150	ASME B16.5	F304/F304L	Lap joint flange	N06022 stub
541	1-1/2"	CL300	ASME B16.5	F304/F304L	Lap joint flange	N06022 stub
544	2"	CL150	ASME B16.5	F304/F304L	Lap joint flange	N06022 stub
545	2"	CL300	ASME B16.5	F304/F304L	Lap joint flange	N06022 stub
549	DN50	PN40	EN 1092-1	F304/F304L	Lap joint flange	Type B1, N06022 stub

(1) Only available on model CMFS100H.

Model CMFS100P and CMFS150P (high pressure)

Code	Description					
180	DN25	PN100	EN 1092-1	F316/F316L	Weld neck flange	Type B2
185	DN25	PN250	EN 1092-1	F316/F316L	Weld neck flange	Type B2
362	DN40	PN160	EN 1092-1	F316/F316L	Weld neck flange	Type B2
364	DN40	PN250	EN 1092-1	F316/F316L	Weld neck flange	Type B2
370	DN50	PN160	EN 1092-1	F316/F316L	Weld neck flange	Type B2
483	DN50	PN250	EN 1092-1	F316/F316L	Weld neck flange	Type B2

Model CMF010H, CMF025H, and CMF050H (nickel alloy C22)

Code	Description					
323 ⁽¹⁾	#4		VCO	N06022	Swagelok compatible fitting	1/4" N10276 NPT female adapter
334 ⁽¹⁾	#4		VCO	N06022	Swagelok compatible fitting	
520	1/2-inch	CL150	ASME B16.5	F304/F304L	Lap joint flange	N06022 stub
521	1/2-inch	CL300	ASME B16.5	F304/F304L	Lap joint flange	N06022 stub
522	15mm	10K	JIS B 2220	F304/F304L	Lap joint flange	N06022 stub
523	DN15	PN40	DIN 2656	F304/F304L	Lap joint flange	Form C face, N06022 stub
524	DN15	PN40	EN 1092-1	F304/F304L	Lap joint flange	Type B1, N06022 stub

(1) Only available on model CMF010H.

Model CMF010L, CMF025L, and CMF050L (304L stainless steel)

Code	Description					
413	1/2"	CL150	ASME B16.5	F304/F304L	Weld neck flange	Raised face
414	1/2"	CL300	ASME B16.5	F304/F304L	Weld neck flange	Raised face

Code	Description					
421	DN15	PN40	EN 1092-1	F304/F304L	Weld neck flange	Type B1
423	DN15	PN40	DIN 2526	F304/F304L	Weld neck flange	Form C face

Model CMF010M (316L stainless steel)

Code	Description					
172	DN25	PN40	EN 1092-1	F316/F316L	Weld neck flange	Type B1
176	DN15	PN40	EN 1092-1	F316/F316L	Weld neck flange	Type B1
177	DN15	PN100	EN 1092-1	F316/F316L	Weld neck flange	Type B2
178	DN15	PN100	EN 1092-1	F316/F316L	Weld neck flange	Type D
183	DN25	PN40	EN 1092-1	F316/F316L	Weld neck flange	Type D
300	DN15	PN40	DIN 2635	F316/F316L	Weld neck flange	Form C face
302	DN15	PN100	DIN 2637	F316/F316L	Weld neck flange	Form E face
304	15mm	10K	JIS B 2220	F316/F316L	Weld neck flange	Raised face
305	15mm	20K	JIS B 2220	F316/F316L	Weld neck flange	Raised face
310	DN15	PN40	EN 1092-1	F316/F316L	Weld neck flange	Type D
313	1/2"	CL150	ASME B16.5	F316/F316L	Weld neck flange	Raised face
314	1/2"	CL300	ASME B16.5	F316/F316L	Weld neck flange	Raised face
315	1/2"	CL600	ASME B16.5	F316/F316L	Weld neck flange	Raised face
321	1/2"		Tri-Clamp compatible	316L	Hygienic fitting	
323	#4		VCO	316/316L	Swagelok compatible fitting	1/4" NPT female adapter
324	#4		VCO	316/316L	Swagelok compatible fitting	1/4" tube compression fitting adapter
325	#4		VCO	316/316L	Swagelok compatible fitting	6mm tube compression fitting adapter
334	#4		VCO	316/316L	Swagelok compatible fitting	

Model CMF010P (high pressure)

Code	Description					
323	#4		VCO	316/316L	Swagelok compatible fitting	1/4" NPT female adapter
324	#4		VCO	316/316L	Swagelok compatible fitting	1/4" tube compression fitting adapter
325	#4		VCO	316/316L	Swagelok compatible fitting	6mm tube compression fitting adapter

Code	Description					
334	#4		VCO	316/316L	Swagelok compatible fitting	

Model CMF025M (316L stainless steel)

Code	Description					
172	DN25	PN40	EN 1092-1	F316/F316L	Weld neck flange	Type B1
176	DN15	PN40	EN 1092-1	F316/F316L	Weld neck flange	Type B1
177	DN15	PN100	EN 1092-1	F316/F316L	Weld neck flange	Type B2
178	DN15	PN100	EN 1092-1	F316/F316L	Weld neck flange	Type D
183	DN25	PN40	EN 1092-1	F316/F316L	Weld neck flange	Type D
300	DN15	PN40	DIN 2635	F316/F316L	Weld neck flange	Form C face
301	DN15	PN40	DIN 2635	F316/F316L	Weld neck flange	Form N grooved face
302	DN15	PN100	DIN 2637	F316/F316L	Weld neck flange	Form E face
303	DN15	PN100	DIN 2637	F316/F316L	Weld neck flange	Form N grooved face
304	15mm	10K	JIS B 2220	F316/F316L	Weld neck flange	Raised face
305	15mm	20K	JIS B 2220	F316/F316L	Weld neck flange	Raised face
310	DN15	PN40	EN 1092-1	F316/F316L	Weld neck flange	Type D
313	1/2"	CL150	ASME B16.5	F316/F316L	Weld neck flange	Raised face
314	1/2"	CL300	ASME B16.5	F316/F316L	Weld neck flange	Raised face
315	1/2"	CL600	ASME B16.5	F316/F316L	Weld neck flange	Raised face
319	#8		VCO	316/316L	Swagelok compatible fitting	1/2" NPT female adapter
321	1/2"		Tri-Clamp compatible	316L	Hygienic fitting	
335	#8		VCO	316/316L	Swagelok compatible fitting	

Model CMF050M (316L stainless steel)

Code	Description					
172	DN25	PN40	EN 1092-1	F316/F316L	Weld neck flange	Type B1
176	DN15	PN40	EN 1092-1	F316/F316L	Weld neck flange	Type B1
177	DN15	PN100	EN 1092-1	F316/F316L	Weld neck flange	Type B2
178	DN15	PN100	EN 1092-1	F316/F316L	Weld neck flange	Type D
183	DN25	PN40	EN 1092-1	F316/F316L	Weld neck flange	Type D
300	DN15	PN40	DIN 2635	F316/F316L	Weld neck flange	Form C face

Code	Description					
301	DN15	PN40	DIN 2635	F316/F316L	Weld neck flange	Form N grooved face
302	DN15	PN100	DIN 2637	F316/F316L	Weld neck flange	Form E face
303	DN15	PN100	DIN 2637	F316/F316L	Weld neck flange	Form N grooved face
304	15mm	10K	JIS B 2220	F316/F316L	Weld neck flange	Raised face
305	15mm	20K	JIS B 2220	F316/F316L	Weld neck flange	Raised face
310	DN15	PN40	EN 1092-1	F316/F316L	Weld neck flange	Type D
313	1/2"	CL150	ASME B16.5	F316/F316L	Weld neck flange	Raised face
314	1/2"	CL300	ASME B16.5	F316/F316L	Weld neck flange	Raised face
315	1/2"	CL600	ASME B16.5	F316/F316L	Weld neck flange	Raised face
319	#8		VCO	316/316L	Swagelok compatible fitting	1/2" NPT female adapter
320	#12		VCO	316/316L	Swagelok compatible fitting	3/4" NPT female adapter
322	3/4"		Tri-Clamp compatible	316L	Hygienic fitting	
336	#12		VCO	316/316L	Swagelok compatible fitting	

Model CMF100H (nickel alloy C22)

Code	Description					
530	1"	CL150	ASME B16.5	F304/F304L	Lap joint flange	N06022 stub
531	1"	CL300	ASME B16.5	F304/F304L	Lap joint flange	N06022 stub
532	25mm	10K	JIS B 2220	F304/F304L	Lap joint flange	N06022 stub
533	DN25	PN40	DIN 2656	F304/F304L	Lap joint flange	Form C face, N06022 stub
534	DN25	PN40	EN 1092-1	F304/F304L	Lap joint flange	Type B1, N06022 stub

Model CMF100L (304L stainless steel)

Code	Description					
415	1"	CL150	ASME B16.5	F304/F304L	Weld neck flange	Raised face
416	1"	CL300	ASME B16.5	F304/F304L	Weld neck flange	Raised face
422	DN25	PN40	EN 1092-1	F304/F304L	Weld neck flange	Type B1
424	DN25	PN40	DIN 2526	F304/F304L	Weld neck flange	Form C face

Model CMF100M (316L stainless steel)

Code	Description					
179	DN25	PN40	EN 1092-1	F316/F316L	Weld neck flange	Type B1
180	DN25	PN100	EN 1092-1	F316/F316L	Weld neck flange	Type B2
181	DN25	PN100	EN 1092-1	F316/F316L	Weld neck flange	Type D
306	DN25	PN40	DIN 2635	F316/F316L	Weld neck flange	Form C face
307	DN25	PN40	DIN 2635	F316/F316L	Weld neck flange	Form N grooved face
308	DN25	PN100	DIN 2637	F316/F316L	Weld neck flange	Form E face
309	DN25	PN100	DIN 2637	F316/F316L	Weld neck flange	Form N grooved face
311	DN25	PN40	EN 1092-1	F316/F316L	Weld neck flange	Type D
317	25mm	10K	JIS B 2220	F316/F316L	Weld neck flange	Raised face
318	25mm	20K	JIS B 2220	F316/F316L	Weld neck flange	Raised face
328	1"	CL150	ASME B16.5	F316/F316L	Weld neck flange	Raised face
329	1"	CL300	ASME B16.5	F316/F316L	Weld neck flange	Raised face
330	1"	CL600	ASME B16.5	F316/F316L	Weld neck flange	Raised face
331	1-1/2"	CL600	ASME B16.5	F316/F316L	Weld neck flange	Raised face
339	1"		Tri-Clamp compatible	316L	Hygienic fitting	

Model CMF200H and Model CMF200B (standard or high temperature nickel alloy C22)

Code	Description					
537	1-1/2"	CL600	ASME B16.5	F304/F304L	Lap joint flange	N06022 stub
540	1-1/2"	CL150	ASME B16.5	F304/F304L	Lap joint flange	N06022 stub
541	1-1/2"	CL300	ASME B16.5	F304/F304L	Lap joint flange	N06022 stub
542	40mm	10K	JIS B 2220	F304/F304L	Lap joint flange	N06022 stub
543	DN40	PN40	DIN 2656	F304/F304L	Lap joint flange	Form C face, N06022 stub
544	2"	CL150	ASME B16.5	F304/F304L	Lap joint flange	N06022 stub
545	2"	CL300	ASME B16.5	F304/F304L	Lap joint flange	N06022 stub
546	50mm	10K	JIS B 2220	F304/F304L	Lap joint flange	N06022 stub
547	DN50	PN40	DIN 2656	F304/F304L	Lap joint flange	Form C face, N06022 stub
548	DN40	PN40	EN 1092-1	F304/F304L	Lap joint flange	Type B1, N06022 stub

Code	Description					
549	DN50	PN40	EN 1092-1	F304/F304L	Lap joint flange	Type B1, N06022 stub

Model CMF200L (304L stainless steel)

Code	Description					
441	1-1/2"	CL150	ASME B16.5	F304/F304L	Weld neck flange	Raised face
442	1-1/2"	CL300	ASME B16.5	F304/F304L	Weld neck flange	Raised face
457	DN40	PN40	EN 1092-1	F304/F304L	Weld neck flange	Type B1
458	DN50	PN40	EN 1092-1	F304/F304L	Weld neck flange	Type B1
481	DN40	PN40	DIN 2526	F304/F304L	Weld neck flange	Form C face
482	DN50	PN40	DIN 2526	F304/F304L	Weld neck flange	Form C face
518	2-inch	CL150	ASME B16.5	F304/F304L	Weld neck flange	Raised face
519	2-inch	CL300	ASME B16.5	F304/F304L	Weld neck flange	Raised face

Model CMF200M and Model CMF200A (standard or high temperature 316L stainless steel)

Code	Description					
312	DN40	PN40	EN 1092-1	F316/F316L	Weld neck flange	Type D
316	DN50	PN40	EN 1092-1	F316/F316L	Weld neck flange	Type D
341	1-1/2-inch	CL150	ASME B16.5	F316/F316L	Weld neck flange	Raised face
342	1-1/2-inch	CL300	ASME B16.5	F316/F316L	Weld neck flange	Raised face
343	1-1/2-inch	CL600	ASME B16.5	F316/F316L	Weld neck flange	Raised face
351 ⁽¹⁾	1-1/2-inch		Tri-Clamp compatible	316L	Hygienic fitting	
352 ⁽²⁾	2-inch		Tri-Clamp compatible	316L	Hygienic fitting	
363	DN40	PN100	EN 1092-1	F316/F316L	Weld neck flange	Type B2
365	DN50	PN100	EN 1092-1	F316/F316L	Weld neck flange	Type B2
366	DN40	PN100	EN 1092-1	F316/F316L	Weld neck flange	Type D
367	DN50	PN100	EN 1092-1	F316/F316L	Weld neck flange	Type D
368	DN40	PN40	EN 1092-1	F316/F316L	Weld neck flange	Type B1
369	DN50	PN40	EN 1092-1	F316/F316L	Weld neck flange	Type B1

Code	Description					
377	DN40	PN100	DIN 2637	F316/F316L	Weld neck flange	Form E face
378	DN50	PN100	DIN 2637	F316/F316L	Weld neck flange	Form E face
379	DN40	PN100	DIN 2637	F316/F316L	Weld neck flange	Form N grooved face
380	DN50	PN100	DIN 2637	F316/F316L	Weld neck flange	Form N grooved face
381	DN40	PN40	DIN 2635	F316/F316L	Weld neck flange	Form C face
382	DN50	PN40	DIN 2635	F316/F316L	Weld neck flange	Form C face
383	DN40	PN40	DIN 2635	F316/F316L	Weld neck flange	Form N grooved face
384	DN50	PN40	DIN 2635	F316/F316L	Weld neck flange	Form N grooved face
385	40mm	10K	JIS B 2220	F316/F316L	Weld neck flange	Raised face
386	50mm	10K	JIS B 2220	F316/F316L	Weld neck flange	Raised face
387	40mm	20K	JIS B 2220	F316/F316L	Weld neck flange	Raised face
388	50mm	20K	JIS B 2220	F316/F316L	Weld neck flange	Raised face
418	2-inch	CL150	ASME B16.5	F316/F316L	Weld neck flange	Raised face
419	2-inch	CL300	ASME B16.5	F316/F316L	Weld neck flange	Raised face
420	2-inch	CL600	ASME B16.5	F316/F316L	Weld neck flange	Raised face

(1) Fitting code 351 is not available with high temperature models (base model variation code A).

(2) Fitting code 352 is not available with high temperature models (base model variation code A).

Model CMF300H and Model CMF300B (standard or high temperature nickel alloy C22)

Code	Description					
539	3"	CL600	ASME B16.5	F304/F304L	Lap joint flange	N06022 stub
550	3"	CL150	ASME B16.5	F304/F304L	Lap joint flange	N06022 stub
551	3"	CL300	ASME B16.5	F304/F304L	Lap joint flange	N06022 stub
552	80mm	10K	JIS B 2220	F304/F304L	Lap joint flange	N06022 stub
553	DN80	PN40	DIN 2656	F304/F304L	Lap joint flange	Form C face, N06022 stub
554	DN80	PN40	EN 1092-1	F304/F304L	Lap joint flange	Type B1, N06022 stub

Model CMF300L (304L stainless steel)

Code	Description					
455	3"	CL150	ASME B16.5	F304/F304L	Weld neck flange	Raised face
456	3"	CL300	ASME B16.5	F304/F304L	Weld neck flange	Raised face
459	DN80	PN40	EN 1092-1	F304/F304L	Weld neck flange	Type B1
491	DN80	PN40	DIN 2526	F304/F304L	Weld neck flange	Form C face

Model CMF300M and Model CMF300A (standard or high temperature 316L stainless steel)

Code	Description					
326	DN80	PN40	EN 1092-1	F316/F316L	Weld neck flange	Type D
333	DN100	PN40	EN 1092-1	F316/F316L	Weld neck flange	Type D
355	3"	CL150	ASME B16.5	F316/F316L	Weld neck flange	Raised face
356	3"	CL300	ASME B16.5	F316/F316L	Weld neck flange	Raised face
357	3"	CL600	ASME B16.5	F316/F316L	Weld neck flange	Raised face
358	3"	CL900	ASME B16.5	F316/F316L	Weld neck flange	Raised face
359	DN100	PN100	EN 1092-1	F316/F316L	Weld neck flange	Type D
361 ⁽¹⁾	3"		Tri-Clamp compatible	316L	Hygienic fitting	
371	DN80	PN40	EN 1092-1	F316/F316L	Weld neck flange	Type B1
372	DN100	PN40	EN 1092-1	F316/F316L	Weld neck flange	Type B1
373	DN80	PN100	EN 1092-1	F316/F316L	Weld neck flange	Type B2
374	DN100	PN100	EN 1092-1	F316/F316L	Weld neck flange	Type B2
375	DN80	PN100	EN 1092-1	F316/F316L	Weld neck flange	Type D
391	DN80	PN40	DIN 2635	F316/F316L	Weld neck flange	Form C face
392	DN100	PN40	DIN 2635	F316/F316L	Weld neck flange	Form C face
393	DN80	PN40	DIN 2635	F316/F316L	Weld neck flange	Form N grooved face
394	DN100	PN40	DIN 2635	F316/F316L	Weld neck flange	Form N grooved face
395	DN80	PN100	DIN 2637	F316/F316L	Weld neck flange	Form E face
396	DN100	PN100	DIN 2637	F316/F316L	Weld neck flange	Form E face
397	DN80	PN100	DIN 2637	F316/F316L	Weld neck flange	Form N grooved face
398	DN100	PN100	DIN 2637	F316/F316L	Weld neck flange	Form N grooved face
400	80mm	10K	JIS B 2220	F316/F316L	Weld neck flange	Raised face
401	100mm	10K	JIS B 2220	F316/F316L	Weld neck flange	Raised face
402	80mm	20K	JIS B 2220	F316/F316L	Weld neck flange	Raised face
425	4"	CL150	ASME B16.5	F316/F316L	Weld neck flange	Raised face
426	4"	CL300	ASME B16.5	F316/F316L	Weld neck flange	Raised face
427	4"	CL600	ASME B16.5	F316/F316L	Weld neck flange	Raised face
428	4"	CL900	ASME B16.5	F316/F316L	Weld neck flange	Raised face

(1) Only available with model CMF300M.

Model CMF350M and CMF350A (standard or high temperature 316L stainless steel)

Code	Description					
435	4"	CL150	ASME B16.5	F316/F316L	Weld neck flange	Raised face
436	4"	CL300	ASME B16.5	F316/F316L	Weld neck flange	Raised face
437	4"	CL600	ASME B16.5	F316/F316L	Weld neck flange	Raised face
443 ⁽¹⁾	DN100	PN40	EN 1092-1	F316/F316L	Weld neck flange	Type B1
445 ⁽¹⁾	DN100	PN100	EN 1092-1	F316/F316L	Weld neck flange	Type B2
447 ⁽¹⁾	DN100	PN100	EN 1092-1	F316/F316L	Weld neck flange	Type D
470	100mm	10K	JIS B 2220	F316/F316L	Weld neck flange	Raised face
472	100mm	20K	JIS B 2220	F316/F316L	Weld neck flange	Raised face
480	DN100	PN40	EN 1092-1	F316/F316L	Weld neck flange	Type D

(1) Not available with approval code T or J.

Model CMF400H and Model CMF400B (standard or high temperature nickel alloy C22)

Code	Description					
906	DN100	PN40	EN 1092-1	N06022	Weld neck flange	Type B1
908	DN100	PN100	EN 1092-1	N06022	Lap joint flange	Type B2
910	DN100	PN160	EN 1092-1	N06022	Lap joint flange	Type B2
911	4"	CL150	ASME B16.5	N06022	Weld neck flange	Raised face
912	4"	CL300	ASME B16.5	N06022	Weld neck flange	Raised face
913	4"	CL600	ASME B16.5	N06022	Weld neck flange	Raised face
914	4"	CL900	ASME B16.5	N06022	Weld neck flange	Raised face

Model CMF400M and CMF400A (standard or high temperature 316L stainless steel)

Code	Description					
435	4"	CL150	ASME B16.5	F316/F316L	Weld neck flange	Raised face
436	4"	CL300	ASME B16.5	F316/F316L	Weld neck flange	Raised face
437	4"	CL600	ASME B16.5	F316/F316L	Weld neck flange	Raised face
438	4"	CL900	ASME B16.5	F316/F316L	Weld neck flange	Raised face
439	4"	CL1500	ASME B16.5	F316/F316L	Weld neck flange	Raised face
443 ⁽¹⁾	DN100	PN40	EN 1092-1	F316/F316L	Weld neck flange	Type B1
444 ⁽¹⁾	DN150	PN40	EN 1092-1	F316/F316L	Weld neck flange	Type B1
445 ⁽¹⁾	DN100	PN100	EN 1092-1	F316/F316L	Weld neck flange	Type B2
446 ⁽¹⁾	DN150	PN100	EN 1092-1	F316/F316L	Weld neck flange	Type B2

Code	Description					
447 ⁽¹⁾	DN100	PN100	EN 1092-1	F316/F316L	Weld neck flange	Type D
448 ⁽¹⁾	DN150	PN100	EN 1092-1	F316/F316L	Weld neck flange	Type D
451	6"	CL150	ASME B16.5	F316/F316L	Weld neck flange	Raised face
452	6"	CL300	ASME B16.5	F316/F316L	Weld neck flange	Raised face
453	6"	CL600	ASME B16.5	F316/F316L	Weld neck flange	Raised face
460	DN100	PN40	DIN 2635	F316/F316L	Weld neck flange	Form C face
461	DN150	PN40	DIN 2635	F316/F316L	Weld neck flange	Form C face
462	DN100	PN40	DIN 2635	F316/F316L	Weld neck flange	Form N grooved face
463	DN150	PN40	DIN 2635	F316/F316L	Weld neck flange	Form N grooved face
464	DN100	PN100	DIN 2637	F316/F316L	Weld neck flange	Form E face
465	DN150	PN100	DIN 2637	F316/F316L	Weld neck flange	Form E face
466	DN100	PN100	DIN 2637	F316/F316L	Weld neck flange	Form N grooved face
467	DN150	PN100	DIN 2637	F316/F316L	Weld neck flange	Form N grooved face
470	100mm	10K	JIS B 2220	F316/F316L	Weld neck flange	Raised face
471	150mm	10K	JIS B 2220	F316/F316L	Weld neck flange	Raised face
472	100mm	20K	JIS B 2220	F316/F316L	Weld neck flange	Raised face
473 ⁽²⁾	150mm	20K	JIS B 2220	F316/F316L	Weld neck flange	Raised face
478	DN150	PN40	EN 1092-1	F316/F316L	Weld neck flange	Type D
480	DN100	PN40	EN 1092-1	F316/F316L	Weld neck flange	Type D

(1) Not available with approval code T or J.

(2) Applies to Model CMF400A only.

Model CMF350P (high pressure)

Code	Description					
437	4"	CL600	ASME B16.5	F316/F316L	Weld neck flange	Raised face
438	4"	CL900	ASME B16.5	F316/F316L	Weld neck flange	Raised face
445	DN100	PN100	EN 1092-1	F316/F316L	Weld neck flange	Type B2
447	DN100	PN100	EN 1092-1	F316/F316L	Weld neck flange	Type D
468	DN100	PN160	EN 1092-1	F316/F316L	Weld neck flange	Type B2
472	100mm	20K	JIS B 2220	F316/F316L	Weld neck flange	Raised face
473	150mm	20K	JIS B 2220	F316/F316L	Weld neck flange	Raised face
562	4"	CL600	ASME B16.5	A105 Carbon Steel	Lap joint flange	316/316L stub

Code	Description					
563	4"	CL900	ASME B16.5	A105 Carbon Steel	Lap joint flange	316/316L stub

Model CMF400P (high pressure)

Code	Description					
437	4"	CL600	ASME B16.5	F316/F316L	Weld neck flange	Raised face
438 ⁽¹⁾	4"	CL900	ASME B16.5	F316/F316L	Weld neck flange	Raised face
439	4"	CL1500	ASME B16.5	F316/F316L	Weld neck flange	Raised face
445 ⁽¹⁾	DN100	PN100	EN 1092-1	F316/F316L	Weld neck flange	Type B2
446 ⁽¹⁾	DN150	PN100	EN 1092-1	F316/F316L	Weld neck flange	Type B2
447 ⁽¹⁾	DN100	PN100	EN 1092-1	F316/F316L	Weld neck flange	Type D
448 ⁽¹⁾	DN150	PN100	EN 1092-1	F316/F316L	Weld neck flange	Type D
453	6"	CL600	ASME B16.5	F316/F316L	Weld neck flange	Raised face
468	DN100	PN160	EN 1092-1	F316/F316L	Weld neck flange	Type B2
472	100mm	20K	JIS B 2220	F316/F316L	Weld neck flange	Raised face
473	150mm	20K	JIS B 2220	F316/F316L	Weld neck flange	Raised face
562	4"	CL600	ASME B16.5	A105 Carbon Steel	Lap joint flange	316/316L stub
563	4"	CL900	ASME B16.5	A105 Carbon Steel	Lap joint flange	316/316L stub

(1) Not available with approval code T or J.

Model CMFHC2M and Model CMFHC2A (standard or high temperature 316L stainless steel)

Code	Description					
451	6"	CL150	ASME B16.5	F316/F316L	Weld neck flange	Raised face
452	6"	CL300	ASME B16.5	F316/F316L	Weld neck flange	Raised face
453	6"	CL600	ASME B16.5	F316/F316L	Weld neck flange	Raised face
801	DN200	PN40	EN 1092-1	F316/F316L	Weld neck flange	Type B1
802	DN200	PN100	EN 1092-1	F316/F316L	Weld neck flange	Type B2
803	DN200	PN160	EN 1092-1	F316/F316L	Weld neck flange	Type B2
810	8-inch	CL150	ASME B16.5	F316/F316L	Weld neck flange	Raised face
811	8-inch	CL300	ASME B16.5	F316/F316L	Weld neck flange	Raised face
818	8-inch	CL600	ASME B16.5	F316/F316L	Weld neck flange	Raised face

Code	Description					
819	8-inch	CL900	ASME B16.5	F316/F316L	Weld neck flange	Raised face
821	6-inch	CL900	ASME B16.5	F316/F316L	Weld neck flange	Raised face
822	DN150	PN40	EN 1092-1	F316/F316L	Weld neck flange	Type B1
823	DN150	PN100	EN 1092-1	F316/F316L	Weld neck flange	Type B2
824	DN150	PN160	EN 1092-1	F316/F316L	Weld neck flange	Type B2

Model CMFHC2Y (Super Duplex UNS S32750)

Code	Description					
956	DN200	PN40	EN 1092-1	Super duplex	Weld neck flange	Type B1
957	DN200	PN100	EN 1092-1	Super duplex	Weld neck flange	Type B2
958	DN200	PN160	EN 1092-1	Super duplex	Weld neck flange	Type B2
959	DN150	PN40	EN 1092-1	Super duplex	Weld neck flange	Type B1
960	DN150	PN100	EN 1092-1	Super duplex	Weld neck flange	Type B2
961	DN150	PN160	EN 1092-1	Super duplex	Weld neck flange	Type B2
962	8-inch	CL150	ASME B16.5	Super duplex	Weld neck flange	Raised face
963	8-inch	CL300	ASME B16.5	Super duplex	Weld neck flange	Raised face
964	8-inch	CL600	ASME B16.5	Super duplex	Weld neck flange	Raised face
965	8-inch	CL900	ASME B16.5	Super duplex	Weld neck flange	Raised face
966	6-inch	CL150	ASME B16.5	Super duplex	Weld neck flange	Raised face
967	6-inch	CL300	ASME B16.5	Super duplex	Weld neck flange	Raised face
968	6-inch	CL600	ASME B16.5	Super duplex	Weld neck flange	Raised face
969	6-inch	CL900	ASME B16.5	Super duplex	Weld neck flange	Raised face

Model CMFHC3M and Model CMFHC3A (standard or high temperature 316L stainless steel)

Code	Description					
801	DN200	PN40	EN 1092-1	F316/F316L	Weld neck flange	Type B1
802	DN200	PN100	EN 1092-1	F316/F316L	Weld neck flange	Type B2
803	DN200	PN160	EN 1092-1	F316/F316L	Weld neck flange	Type B2
804	DN250	PN40	EN 1092-1	F316/F316L	Weld neck flange	Type B1
805	DN250	PN100	EN 1092-1	F316/F316L	Weld neck flange	Type B2
806	DN250	PN160	EN 1092-1	F316/F316L	Weld neck flange	Type B2
810	8-inch	CL150	ASME B16.5	F316/F316L	Weld neck flange	Raised face

Code	Description					
811	8-inch	CL300	ASME B16.5	F316/F316L	Weld neck flange	Raised face
812	8-inch	CL600	ASME B16.5	A105 Carbon Steel	Lap joint flange	316/316L stub
813	10-inch	CL150	ASME B16.5	F316/F316L	Weld neck flange	Raised face
814	10-inch	CL300	ASME B16.5	F316/F316L	Weld neck flange	Raised face
815	10-inch	CL600	ASME B16.5	F316/F316L	Weld neck flange	Raised face
816	10-inch	CL600	ASME B16.5	A105 Carbon Steel	Lap joint flange	316/316L stub
817	10-inch	CL600	ASME B16.5	F316/F316L	Weld neck flange	Raised face
818	8-inch	CL600	ASME B16.5	F316/F316L	Weld neck flange	Raised face
819	8-inch	CL900	ASME B16.5	F316/F316L	Weld neck flange	Raised face
820	10-inch	CL900	ASME B16.5	F316/F316L	Weld neck flange	Raised face

Model CMFHC3Y (Super Duplex UNS S32750)

Code	Description					
825	DN200	PN40	EN 1092-1	Super duplex	Weld neck flange	Type B1
826	DN200	PN100	EN 1092-1	Super duplex	Weld neck flange	Type B2
827	DN200	PN160	EN 1092-1	Super duplex	Weld neck flange	Type B2
828	DN250	PN40	EN 1092-1	Super duplex	Weld neck flange	Type B1
829	DN250	PN100	EN 1092-1	Super duplex	Weld neck flange	Type B2
830	DN250	PN160	EN 1092-1	Super duplex	Weld neck flange	Type B2
831	8-inch	CL150	ASME B16.5	Super duplex	Weld neck flange	Raised face
832	8-inch	CL300	ASME B16.5	Super duplex	Weld neck flange	Raised face
833	8-inch	CL600	ASME B16.5	Super duplex	Weld neck flange	Raised face
834	8-inch	CL900	ASME B16.5	Super duplex	Weld neck flange	Raised face
836	10-inch	CL150	ASME B16.5	Super duplex	Weld neck flange	Raised face
837	10-inch	CL300	ASME B16.5	Super duplex	Weld neck flange	Raised face
838	10-inch	CL600	ASME B16.5	Super duplex	Weld neck flange	Raised face
839	10-inch	CL900	ASME B16.5	Super duplex	Weld neck flange	Raised face

Model CMFHC4M (316L stainless steel)

Code	Description					
841	10-inch	CL150	ASME B16.5	F316/F316L	Weld neck flange	Raised face
842	10-inch	CL300	ASME B16.5	F316/F316L	Weld neck flange	Raised face
843	10-inch	CL600	ASME B16.5	F316/F316L	Weld neck flange	Raised face
844	10-inch	CL900	ASME B16.5	F316/F316L	Weld neck flange	Raised face
845	12-inch	CL150	ASME B16.5	F316/F316L	Weld neck flange	Raised face
846	12-inch	CL300	ASME B16.5	F316/F316L	Weld neck flange	Raised face
847	12-inch	CL600	ASME B16.5	F316/F316L	Weld neck flange	Raised face
848	12-inch	CL900	ASME B16.5	F316/F316L	Weld neck flange	Raised face
849	DN250	PN40	EN 1092-1	F316/F316L	Weld neck flange	Type B1
850	DN250	PN100	EN 1092-1	F316/F316L	Weld neck flange	Type B2
851	DN250	PN160	EN 1092-1	F316/F316L	Weld neck flange	Type B2
852	DN300	PN40	EN 1092-1	F316/F316L	Weld neck flange	Type B1
853	DN300	PN100	EN 1092-1	F316/F316L	Weld neck flange	Type B2
854	DN300	PN160	EN 1092-1	F316/F316L	Weld neck flange	Type B2

Case and hygienic options**Code descriptions**

Code	Description
N	Standard case; 300-series stainless steel
D	Standard case; 300-series stainless steel; with rupture disk (either a single 1/2-inch NPT male or a single 1-inch NPT male, depending on line size)
P	Standard case; 300-series stainless steel; with one drain or two purge fittings ⁽¹⁾
M	316L stainless steel case
K	316L stainless steel case; with one drain or two purge fittings ⁽¹⁾
H	316L stainless steel case; hygienic finish: 32 Ra (0.8 μm) Flow Path ⁽²⁾
R	316L stainless steel case with rupture disk (a single 1/2-inch NPT male)

(1) CMFS models have one 1/2-inch female NPT drain fitting; CMF350 and CMF400 models have two 1-inch NPT female purge fittings; all other models have two 1/2-inch NPT female purge fittings.

(2) Only available with process connection code 321, 344, 345, or 346.

Codes available by model

Model	Available codes						
	N	D	P	M	K	H	R
CMFS***M/H/P	N	D	P	M	K	H ⁽¹⁾	R
CMF350M	N		P	M	K		
CMF350A	N	D		M			
CMF***M/L/H/P (not including models listed above)	N		P				
CMFHC***M/Y/A and CMF***A/B (not including models listed above)	N						

(1) 316L hygienic option only available on CMFS010M and CMFS015M.

Electronics interface

Code descriptions

Code	Description
0	Model 2400S transmitter
1	Extended mount Model 2400S transmitter
2	4-wire polyurethane-painted aluminum integral enhanced core processor for remote mount transmitters
3 ⁽¹⁾	4-wire stainless steel integral enhanced core processor for remote mount transmitters;
4	4-wire polyurethane-painted aluminum integral extended mount enhanced core processor for remote mount transmitters
5 ⁽¹⁾	4-wire extended mount stainless steel integral enhanced core processor for remote mount transmitters
6 ⁽²⁾	MVDSolo; polyurethane-painted aluminum integral enhanced core processor (for OEMs); when ordered with approval C, A, Z, I, MVD Direct Connect™ I.S. barrier is supplied; not available with approval code U
7 ⁽¹⁾⁽²⁾	MVDSolo; stainless steel integral enhanced core processor (for OEMs); when ordered with approval C, A, Z, I, MVD Direct Connect™ I.S. barrier is supplied; not available with approval code U
8 ⁽²⁾	MVDSolo; extended mount polyurethane-painted aluminum integral enhanced core processor (for OEMs); when ordered with approval C, A, Z, I, MVD Direct Connect™ I.S. barrier is supplied
9 ⁽¹⁾⁽²⁾	MVDSolo; extended mount stainless steel enhanced core processor (for OEMs); when ordered with approval C, A, Z, I, MVD Direct Connect™ I.S. barrier is supplied
H ⁽³⁾⁽⁴⁾	9-wire extended mount polyurethane-painted aluminum junction box
J ⁽⁵⁾	2-wire integrally mounted Model 2200S transmitter; only available with calibration option C or K
M	For integral mount standard finish FMT Filling transmitter (must order with FMT); must be ordered with FMT Filling transmitter, not sold separately

Code	Description
N	For integral mount improved surface finish (64Ra) FMT Filling transmitter (must order with FMT); must be ordered with FMT Filling transmitter, not sold separately
R ⁽⁴⁾	9-wire polyurethane-painted aluminum junction box
S ⁽⁴⁾	9-wire 316L stainless steel junction box
T ⁽³⁾⁽⁴⁾	9-wire extended mount stainless steel junction box
U ⁽⁵⁾	2-wire extended Model 2200S transmitter; only available with calibration option C or K
F	For integral mount 5700 transmitter

- (1) Not available with KH Special Test, and not recommended for truck mount.
- (2) When ordered with approval U, C, A, Z, I, P or R, MVD Direct Connect™ I.S. barrier is supplied.
- (3) Not available with approval T, S, L, 5 or J.
- (4) The junction box should not be insulated if the process temperature exceeds 300 °F (150 °C).
- (5) Only available with language code E (English).

Codes available by model

Model	Codes available																			
	F	U	T	S	R	N	M	J	H	9	8	7	6	5	4	3	2	1	0	
All stainless steel CMFS models (M) ⁽¹⁾	F	U	T	S	R	N	M	J	H	9	8	7	6	5	4	3	2	1	0	
All nickel alloy C22 CMFS models (H/P) ⁽¹⁾	F	U	T	S	R			J	H	9	8	7	6	5	4	3	2	1	0	
CMF200A/B, CMF300A/B, CMF400A/B				S	R							7	6			3	2		0	
CMF350A ⁽¹⁾			T	S	R				H			7	6			3	2		0	
CMFHC2M/Y, CMFHC3M/Y, CMFHC4M ⁽¹⁾			T	S	R				H	9	8	7	6	5	4	3	2	1	0	
CMFHC2A, CMFHC3A												7	6			3	2		0	
CMF010M/H/L/P, CMF025M/H/L, CMF050M/H/L, CMF100M/H/L		U	T	S	R			J	H	9	8	7	6	5	4	3	2	1	0	
CMF200M/H/L, CMF300 M/H/L, CMF350M/P ⁽¹⁾ , CMF400M/H/L/P		U	T	S	R			J	H	9	8	7	6	5	4	3	2	1	0	

- (1) Electronic interface codes R, S, H, or T is only available with the enhanced (800) core processor.

Conduit connections

Code descriptions

Code	Description
A	No gland with Electronics Interface codes 0, 1, C, J, M, N, R, S, or U. 3/4-NPT with no gland with any other Electronics Interface codes.
B	1/2-inch NPT - no gland
E	M20 - no gland
F	Brass nickel cable gland (cable diameter 0.335 to 0.394 inches [8.5 to 10 mm])
G	Stainless steel cable gland (cable diameter 0.335 to 0.394 inches [8.5 to 10 mm])
H	Brass nickel cable gland
J ⁽¹⁾	Stainless steel cable gland
K ⁽²⁾	JIS B0202 1/2G - no gland
L ⁽²⁾	Japan - brass nickel cable gland
M ⁽²⁾	Japan - stainless steel cable gland
N ⁽²⁾	JIS B0202 3/4G - no gland
O ⁽²⁾	Japan - brass nickel gland
P ⁽²⁾	Japan - stainless cable gland
Model	with Electronics Interface code

(1) Not available with approval T, S, L, 5 or J.

(2) Only available with approval M, T, S, 5 and L.

Codes available by model

Model	With Electronics Interface code	Available codes													
		P	O	N	M	L	K	J	H	G	F	E	B	A	
All models	0, 1, J, C, M, N, U														A
CMF350P	H, T, R, S	P	O	N				J	H						A
CMFS (All except CMF5010M and CMF5015M), CMFHC2Y, CMFHC3Y	2, 3, 4, 5, 6, 7, 8, 9									G	F	E	B		
CMF200A/B CMF300A/B, CMF350A, CMF400A/B	6, 7														
CMFHC2M, CMFHC3M, CMFHC4M	6, 7, 8, 9														

Model	With Electronics Interface code	Available codes													
		P	O	N	M	L	K	J	H	G	F	E	B	A	
CMF010M/L/H/P, CMF025M/L/H, CMF050M/L/H, CMF100M/L/H, CMF200M/L/H, CMF350M, CMF300M/L/H, CMF400M/H	H, T, 6, 7, 8, 9														
CMF400P	H, T														
CMFS010M, CMFS015M	2, 3, 4, 5, 6, 7, 8, 9				M	L	K				G	F	E	B	
CMF200A/B CMF300A/B, CMF350A, CMF400A/B	2, 3														
CMFHC2A, CMFHC3A	2, 3, 6, 7														
CMFHC2M, CMFHC3M, CMFC4M	2, 3, 4, 5														
CMF010M/L/H/P, CMF025M/L/H, CMF050M/L/H, CMF100M/L/H, CMF200M/L/H, CMF300M/L/H, CMF350M	2, 3, 4, 5														
CMF350P, CMF400P	2, 3, 4, 5, 6, 7, 8, 9														

Approvals

Code descriptions

Code	Description
2	CSA (US and Canada): Class I, Division 2, Groups A,B,C,D
3	IECEX Zone 2
5	TIIS – T5 (IIC) Temperature Classification; not available for quotes outside of Japan; only available with electronic interface code R or S
6 ⁽¹⁾	ATEX - Equipment Category 2 (Zone 1, IIC modified) / PED compliant; models CMF200, CMF300, and CMF400 only
7 ⁽¹⁾	IECEX Zone 1, IIC modified; models CMF200, CMF300, and CMF400 only
8 ⁽¹⁾	NEPSI, IIC modified; only available with language option M (Chinese)
A	CSA (US and Canada): Class I, Division 1, Groups C and D

Code	Description
C	CSA (Canada only)
G	Country Specific Approval – Requires a selection from the Approvals section of the ‘Certificate, Tests, Calibrations and Services’ model code option
I	IECEX Zone 1
J	Hardware ready for TIIS approval; requires conduit connection code E when used with electronics interface code 2, 3, 4, 5, Q, or A
M	Micro Motion Standard; no approval; no barrier included (if applicable)
N	Micro Motion Standard / PED compliant; no approval; no barrier included (if applicable)
P	NEPSI; only available with language option M (Chinese)
L	TIIS – T2 Temperature Classification; not available for quotes outside of Japan
S	TIIS – T3 Temperature Classification; not available for quote outside of Japan
T	TIIS - T4 Temperature Classification, not available for quote outside of Japan (for CMF models); Japan Ex zone 1 (for CMFS models)
V	ATEX - Equipment Category 3 (Zone 2) / PED compliant
Z	ATEX - Equipment Category 2 (Zone 1) / PED compliant
Models	With electronics interface code

(1) Models CMF200, CMF300, CMF400, CMFHC2, CMFHC3, and CMFHC4 are rated for Group IIB with standard ATEX approval code Z, IECEx approval code I, or NEPSI approval code P (where applicable). The IIC modification option (approval codes 6, 7, and 8) should be used only when necessary for the specific area classification.

Codes available by model

Model	With Electronics Interface code	Available codes																		
		Z	V	T	S	L	P	N	M	J	I	G	C	A	8	7	6	5	3	2
All	0, 1, M, N		V					N	M			G							3	2
CMFS007, CMFS025M/H/P, CMFS040M, CMFS050M/H/P, CMFS075M, CMFS100M/H/P, CMFS150M/H/P	2, 3, 4, 5, F	Z		T			P	N	M		I	G		A						2
	6, 7, 8, 9	Z					P	N	M		I	G		A						2
	J, U	Z	V	T				N	M		I	G		A					3	
CMFS010H/P, CMFS015H/P	2, 3, 4, 5	Z		T			P	N	M		I	G		A						
	J, U	Z	V	T				N	M		I	G		A					3	
CMFS010M/H/P, CMFS015M/H/P	6, 7, 8, 9	Z		T			P	N	M		I	G	C	A						
CMFS010M, CMFS015M	2, 3, 4, 5	Z		T			P	N	M		I	G		A						
	J, U	Z	V	T				N	M		I	G		A					3	

Model	With Electronics Interface code	Available codes																		
		Z	V	T	S	L	P	N	M	J	I	G	C	A	8	7	6	5	3	2
CMFS007, CMFS010M/H/P, CMFS015M/H/P, CMFS025M/H/P, CMFS040M, CMFS050M/H/P, CMFS075M, CMFS100M/H/P, CMFS150M/H/P	R, S, H, T	Z					P	N	M		I	G		A						2
CMF010M/H/L, CMF025M/H/L, CMF050M/H/L, CMF100M/H/L, CMF010P	2, 3, 4, 5	Z		T	S	L	P	N	M	J	I	G		A						
	J, U	Z	V					N	M		I	G		A					3	
	A, R, S	Z	V	T	S	L	P	N	M	J	I	G	C	A				5	3	2
	H, T, W, D, 6, 7, 8, 9	Z					P	N	M		I	G	C	A						
CMF200M/H/L, CMF300M/H/L, CMF350M, CMF400M/H/L, CMF350P ⁽¹⁾ , CMF400P ⁽²⁾	2, 3, 4, 5	Z		T	S	L	P	N	M	J	I	G		A	8	7	6			
	J, U	Z	V					N	M		I	G		A					3	
	R, S	Z	V	T	S	L	P	N	M	J	I	G	C	A	8	7	6	5	3	2
	H, T, 6, 7, 8, 9	Z	V				P	N	M		I	G	C	A	8	7	6		3	2
CMF200A/B, CMF300A/B, CMF350A, CMF400A/B	2, 3, C, R, S	Z		T			P	N	M	J	I	G		A						
	6, 7	Z					P	N	M		I	G		A						
CMFHC2Y, CMFHC3Y	2, 3, 4, 5, 6, 7, 8, 9	Z					P	N	M		I	G		A		7	6			
CMFHC2A/M, CMFHC3A/M, CMFHC4M	2, 3, 4, 5	Z		T			P	N	M	J	I	G		A	8	7	6			
	6, 7, 8, 9	Z					P	N	M	J		G		A	8	7	6			

(1) Model CMF350P is not available with approval code T, S, L, J, or 5.

(2) Model CMF400P is only available with approval code U if it is ordered with electronics interface code H or T. Model CMF400P is only available with approval code T, S, or L if it is ordered with electronics interface code R, or S.

Languages

Code	Language option
A	Danish CE requirements document and English installation manual
D	Dutch CE requirements document and English installation manual
E	English installation manual
F	French installation manual
G	German installation manual

Code	Language option
H	Finnish CE requirements document and English installation manual
I	Italian installation manual
J	Japanese installation manual
M	Chinese installation manual
N	Norwegian CE requirements document and English installation manual
O	Polish installation manual
P	Portuguese installation manual
S	Spanish installation manual
W	Swedish CE requirements document and English installation manual
C	Czech installation manual
B	Hungarian CE requirements document and English installation manual
K	Slovak CE requirements document and English installation manual
T	Estonian CE requirements document and English installation manual
U	Greek CE requirements document and English installation manual
L	Latvian CE requirements document and English installation manual
V	Lithuanian CE requirements document and English installation manual
Y	Slovenian CE requirements document and English installation manual

Calibration

Note

There may be additional calibration options or model compatibility beyond what is shown below. For more information, contact a sales representative.

Code	Description ⁽¹⁾⁽²⁾
2 ⁽³⁾	0.05% mass flow and 0.0005 g/cm ³ (0.5 kg/m ³) density calibration
3 ⁽³⁾	0.05% mass flow and 0.0002 g/cm ³ (0.2 kg/m ³) density calibration
6 ⁽³⁾	0.05% mass flow and 0.002 g/cm ³ (2.0 kg/m ³) density calibration
D ⁽³⁾	0.10% mass flow and 0.0002 g/cm ³ (0.2 kg/m ³) density calibration
K	0.10% mass flow and 0.0005 g/cm ³ (0.5 kg/m ³) density calibration
C	0.10% mass flow and 0.002 g/cm ³ (2.0 kg/m ³) density calibration
Z	0.10% mass flow and 0.0005 g/cm ³ (0.5 kg/m ³) density calibration

(1) Accuracy levels apply to liquid only.

(2) Consult Factory for ISO 17025 accredited calibration with 0.014% reference uncertainty.

(3) Requires electronics interface code 0, 1, 2, 3, 4, 5, 6, 7, 8, or 9, or F.

Codes available by model

Model	Available codes						
	Z	C	K	D	6	3	2
CMFS007		C			6		
CMFS010, CMFS015		C	K				2
CMFS025, CMFS040, CMFS050, CMFS075, CMFS100, CMFS150			K	D		3	2
CMF010	Z						2
CMF025, CMF050, CMF100, CMF200H/L/M, CMF300H/L/M, CMF350M/P, CMF400H/M/P	Z			D		3	2
CMF200A/B, CMF300A/B, CMF350A, CMF400A/B,	Z						
CMFHC2, CMFHC3, CMFHC4	Z			D		3	2

Measurement application software

Code	Measurement application software option
A	Petroleum measurement; available only for CMFS models with electronics interface codes 6, 7, 8 and 9; for electronic interface codes 0, 1, 2, 3, 4, or 5, select the petroleum measurement software option on the transmitter
B ⁽¹⁾	Cryogenic application; includes remote enhanced core processor for direct host connection
C ⁽¹⁾	Cryogenic application; includes remote core processor for direct host connection
Z	No measurement application software

(1) Available only for CMF025M, CMF050M, and CMF100M models with electronics interface option R, conduit option A, and approval options M, P, or Z; not available with wafer process connections.

Factory options

Code	Factory option
Z	Standard product
X	ETO product
R	Restocked product (if available)

Certificates, tests, calibrations, and services

These option codes can be added to the end of the model code if needed, but no code is required when none of these options is selected.

Note

There may be additional options or limitations depending on total meter configuration. Contact a sales representative before making your final selections.

Material quality examination tests and certificates

Select any.

Code	Factory option
SD	Super Duplex certification package (hydrostatic test certificate 3.1; material inspection certificate 3.1; ferrite test certificate 3.1; NACE certificate 2.1 MR0175); only available on CMFHC2Y–CMFHC3Y
MC	Material inspection certificate 3.1 (supplier lot traceability per EN 10204); not available separately on CMFHC2Y–CMFHC3Y
NC	NACE certificate 2.1 (MR0175 and MR0103); not available separately on CMFHC2Y–CMFHC3Y
KH	KHK package 3.1 (cert package to accommodate approval in Japan); only available on CMF025–CMF350 and CMF400B, but not available on CMF200B–CMF300B

Radiographic testing

Select only one from this group.

Code	Factory option
RE	X-ray package 3.1 (radiographic examination certificate; weld map; radiographic inspection NDE qualification)
RT	X-Ray package 3.1 (radiographic examination certificate with digital image; weld map; radiographic inspection NDE qualification)

Pressure testing

Select any from this group.

Code	Factory option
HT	Hydrostatic test certificate 3.1 (wetted components only); not available separately on CMFHC2Y–CMFHC3Y
PN	Pneumatic test certificate 3.1; only available on CMF025–CMF400 with base model codes H, P, L, or M
HE	Helium leak test certificate 3.1 (wetted components only)
SL	Sensitive leak test certificate 3.1 (case component only); only available on CMFS007 and CMFS025–CMFS150

Dye penetrant examination

Select any from this group.

Code	Factory option
D1	Dye penetrant test package 3.1 (process connection only; liquid dye penetration NDE qualification)
D2	Dye penetrant test package 3.1 (case only; liquid dye penetration NDE qualification)

Weld examination

Code	Factory option
WP	Weld procedure package (weld map, weld procedure specification, weld procedure qualification record, welder performance qualification)

Positive material testing

Select only one from this group.

Code	Factory option
PM	Positive material test certificate 3.1 (without carbon content)
PC	Positive material test certificate 3.1 (including carbon content); only available on sensors with base model code M, L, or A

Special cleaning

Code	Factory option
O2	Declaration of compliance oxygen service 2.1; not available on CMFHC2–CMFHC4

GOST compliance

Code	Factory option
GR	Russian GOST calibration verification certificate

Accredited Calibration

Select only one from this group.

Code	Factory option
IC	ISO17025 accredited calibration and certificates (9 points total)
BB	MID Calibration for Marine Bunkering; no printer; only available on CMFHC3M with electronics interface code 2–5 and calibration code Z; not available with any other add-on options for special test or calibration

Density calibration

Code	Factory option
DT	Density temperature calibration (only available with "Calibration" option" codes D and 3)

Special calibration options

Select either none, CV, or CV with one of the additional verification point options.

Code	Factory option
CV	Custom verification (alter original verification points)
01	Add 1 additional verification point

Code	Factory option
02	Add 2 additional verification point
03	Add 3 additional verification point
06	Add up to 6 additional verification points
08	Add up to 8 additional verification points
16	Add up to 16 additional verification points

Weights and measures

Code	Factory option
WM	Tag for US NTEP certified applications
WC	Tag for Measurement Canada certified applications

ASME B31.1 Power Piping design code certification

Code	Factory option
GC	B31.1 Power Piping design code certification

Sensor completion

Select any from this group.

Code	Factory option
WG	Witness general
SP	Special packaging

Instrument tagging

Code	Factory option
TG	Instrument tagging – customer information required; maximum 24 characters

Additional hardware

Code	Factory option
PK	2-inch Pipe Mount U-Bolt Kit for electronics; only available on CMF025M, CMF050M, and CMF100M (with measurement application code C) and on CMF200A/B–CMF400A/B and CMFHC2A–CMFHC3A (with any measurement application code)

Country specific approvals

Select one from the following if approval code G is selected.

Code	Factory option
R1	EAC Zone 1 – Hazardous Area Approval ⁽¹⁾⁽²⁾
R2	EAC Zone 1 - IIC modified - Hazardous Area Approval ⁽¹⁾⁽²⁾
R3	EAC Zone 2 – Hazardous Area Approval ⁽¹⁾⁽³⁾
B1	INMETRO Zone 1 - Hazardous Area Approval ⁽¹⁾⁽²⁾
B2	INMETRO Zone 1 - IIC modified - Hazardous Area Approval ⁽¹⁾⁽²⁾
B3	INMETRO Zone 2 – Hazardous Area Approval ⁽¹⁾

(1) Only available with approval code G.

(2) Not available with electronics interface code 0 or 1.

(3) Only available with electronics interface code 0, 1, J, or U.

Emerson Automation Solutions

Worldwide Headquarters
7070 Winchester Circle
Boulder, Colorado USA 80301
T: +1 800-522-6277
T: +1 303-527-5200
F: +1 303-530-8459
Mexico: 52 55 5809 5300
Argentina: 54 11 4837 7000
Brazil: 55 15 3413 8147
Chile: 56 2 2928 4800

Emerson Automation Solutions

Central Europe: +41 41 7686 111
Eastern Europe: +41 41 7686 111
Dubai: +971 4 811 8100
Abu Dhabi: +971 2 697 2000
Austria: +43 2236 607-0
France: 0800 917 901
Germany: +49 (0) 2173 3348 0
Italy: 8008 77334
The Netherlands: +31 (0) 70 413 6666
Belgium: +32 2 716 77 11
Spain: 900 901 986
U.K.: 0870 240 1978
Russian/CIS: +7 495 981 9811

Emerson Automation Solutions

Australia: (61) 3 9721 0200
China: (86) 21 2892 9000
India: (91) 22 6662 0566
Japan: (81) 3 5769 6803
South Korea: (82) 31 8034 0000
Singapore: (65) 6 363 7766

©2019 Micro Motion, Inc. All rights reserved.

The Emerson logo is a trademark and service mark of Emerson Electric Co. Micro Motion, ELITE, ProLink, MVD and MVD Direct Connect marks are marks of one of the Emerson Automation Solutions family of companies. All other marks are property of their respective owners.